

**RPM Indicator with Alarm Operation Guide**

---

---

Masibus Automation and Instrumentation (P) Ltd.  
B/30, GIDC Electronics Estate,  
Sector-25, Gandhinagar-382044, Gujarat, India.  
Phone : +91-79-23287275/79.  
Fax : +91-79-23287281.  
E-mail : sales@masibus.com  
Web : www.masibus.com

---

## Contents

|   |          |
|---|----------|
| Forward   | 4        |
| Notice  | 4        |
| Trademarks  | 4        |
| Revision  | 4        |
| Safety precautions                                  | 4        |
| Handling Precautions for the Unit                   | 5        |
| Checking the content of the package                 | 5        |
| Symbols used in this manual                         | 6        |
| <br>  |          |
| <b>RPM Indicator Overview</b>                       | <b>6</b> |
| <br>  |          |
| <b>Technical details</b>                            | <b>7</b> |
| 1. Display  | 7        |
| 2. Input  | 7        |
| 3. Alarm Control                                    | 7        |
| 4. Transmission output                              | 7        |
| 5. Supply Voltage                                   | 7        |
| 6. Power Consumption                                | 7        |
| 7. Insulation resistance                            | 7        |
| 8. Environment                                      | 7        |
| 9. Case   | 7        |
| 10. Mounting method                                 | 7        |
| 11. Dimension                                       | 7        |
| 12. Weight  | 7        |
| 13. Communication                                   | 7        |
| 14. Safety Standard                                 | 7        |
| 15. Contact Input                                   | 7        |
| 16. Transmitter Power Supply                        | 7        |
| <br>  |          |
| <b>Basic Operation</b>                              | <b>8</b> |
| <br>  |          |
| 1. Overview of display switching and operation keys | 8        |
| 1.1. Keyboard and operation                         | 8        |
| 1.2. Password                                       | 9        |
| 1.3. Operation in main menu                         | 10       |
| 1.4. Zero & Span setting                            | 10       |
| 1.5. Slots setting                                  | 10       |
| 1.6. Retransmission                                 | 10       |
| 1.6.1. Retransmission voltage                       | 10       |
| 1.6.2. Retransmission Current                       | 10       |
| 1.6.3. Retransmission calibration                   | 11       |
| 1.7. Alarm  | 11       |
| 1.7.1. Alarm type                                   | 12       |
| 1.7.2. Select                                       | 12       |
| 1.7.3. Latch  | 12       |
| 1.7.4. Hysteresis                                   | 13       |
| 1.7.5. Set point 1/ Set point 2                     | 13       |
| 1.7.6. Relay delay                                  | 13       |
| 1.7.7. Control relay                                | 13       |
| 1.7.8. Relay Delay                                  | 13       |

|   |           |
|---|-----------|
| 1.8. Communication                      | 13        |
| 1.8.1. Serial Number                    | 14        |
| 1.8.2. Baud rate                        | 14        |
| <b>Calibration Procedure</b>            | <b>15</b> |
| 1.1 Calibration for Retransmission      | 15        |
| <b>Alarm Operation</b>                  | <b>16</b> |
| 1.1. Set point type                     | 16        |
| 1.2. Status of ALARM/TRIP               | 16        |
| 1.3. Latching of Alarm                  | 16        |
| 1.4. HH Logic                           | 16        |
| 1.5. HL Logic                           | 16        |
| 1.6. LL Logic                           | 16        |
| 1.7. Open sensor UP Scale/DOWN Scale    | 17        |
| 1.8. Relay Delay                        | 17        |
| 1.9. Control Relay                      | 17        |
| <b>Installation and Wiring</b>          | <b>20</b> |
| 1.1. Installation Location              | 20        |
| 1.2. Wiring                             | 21        |
| 1.2.1. Wiring Precautions               | 21        |
| 1.2.2. Cutout Dimensions                | 22        |
| 1.2.3. Wiring diagram                   | 23        |
| <b>Parameter</b>                        | <b>24</b> |
| 1.1. Modbus Parameters                  | 24        |
| 1.2. Menu Parameters                    | 25        |
| 1.3. Retransmission output during OvER  | 26        |
| 1.4. Used Modbus functions descriptions | 27        |
| 1.4.1. Read coil status (01)            | 27        |
| 1.4.2. Read Input status (02)           | 28        |
| 1.4.3. Read Holding register(03)        | 28        |
| 1.4.4. Read Input register(04)          | 29        |
| 1.4.5. Force single coil (05)           | 30        |
| 1.4.6. Preset Multiple Registers (16)   | 30        |
| 1.5. Exception responses for Modbus     | 31        |

**Foreword**

Thank you for purchasing 59A series RPM Indicator. This manual describes the basic functions and operation methods of 59A. Please read through this user’s manual carefully before using the product.

**Notice**

The contents of this manual are subject to change without notice as a result of continuing improvements to the instrument’s performance and functions.

Every effort has been made to ensure accuracy in the preparation of this manual. Should any errors or omissions come to your attention, however, please inform MASIBUS Sales office or sales representative.

Under no circumstances may the contents of this manual, in part or in whole, be transcribed or copied without our permission.

**Trademarks**

Our product names or brand names mentioned in this manual are the trademarks or registered trademarks of Masibus Automation and Instrumentation (P) Ltd. (herein after referred to as MASIBUS).

Adobe, Acrobat, and Postscript are either registered trademarks or trademarks of Adobe Systems Incorporated.

All other product names mentioned in this user's manual are trademarks or registered trademarks of their respective companies.

**Safety Precaution**

The following symbols are used in the product and user’s manuals to indicate safety precautions



**“Handle With Care”** (This symbol is attached to the part(s) of the product to indicate that the user’s manual should be referred to in order to protect the operator and the instrument from harm.)



Protective grounding terminal.



Functional grounding terminal (Do not use this terminal as a protective grounding terminal.)



Alternating Current.



Direct Current.

In order to protect the system controlled by this product and the product itself, and to ensure safe operation, observe the safety precautions described in this user’s manual. Use of the instrument in a manner not prescribed herein may compromise the product's functions and the protection features inherent in the device. We assume no liability for safety, or responsibility for the product's quality, performance or functionality should users fail to observe these instructions when operating the product.

Be sure to use the spare parts approved by MASIBUS when replacing parts or consumables.

This product is not designed or manufactured to be used in critical applications that directly affect or threaten human lives. Such applications include nuclear power equipment, devices using radioactivity, railway facilities, aviation equipment, air navigation facilities,

aviation facilities, and medical equipment. If so used, it is the user's responsibility to include in the system additional equipment and devices that ensure personnel safety.

Modification of the product is strictly prohibited.



**Power Supply**

Ensure that the instrument's supply voltage matches the voltage of the power supply before turning ON the power.

**Do Not Use in an Explosive Atmosphere**

Do not operate the instrument in locations with combustible or explosive gases or steam. Operation in such environments constitutes an extreme safety hazard. Use of the instrument in environments with high concentrations of corrosive gas (H<sub>2</sub>S, Sox, etc.) for extended periods of time may cause a failure.

**Do Not Remove Internal Unit**

The internal unit should not be removed by anyone other than MASIBUS's service personnel.

**External Connection**

Ensure that protective grounding is connected before connecting the instrument to the device under measurement or to an external control circuit.

**Damage to the Protective Construction**

Operation of the instrument in a manner not specified in this user's manual may damage its protective construction.

**Warning and Disclaimer**

MASIBUS makes no warranties regarding the product except those stated in the WARRANTY that is provided separately.

The product is provided on an "as is" basis. MASIBUS assumes no liability to any person or entity for any loss or damage, direct or indirect, arising from the use of the product or from any unpredictable defect of the product.

**Handling Precautions for the Main Unit**

The instrument comprises many plastic components. To clean it, wipe it with a soft, dry cloth. Do not use organic solvents such as benzene or thinner for cleaning, as discoloration or deformation may result.

Keep electrically charged objects away from the signal terminals. Not doing so may cause the instrument to fail.

Do not apply volatile chemicals to the display area, operation keys, etc. Do not leave the instrument in contact with rubber or PVC products for extended periods. Doing so may result in failure.

If the equipment emits smoke or abnormal smells or makes unusual noises, turn OFF the instrument's power switch immediately and unplug the device. In such an event, contact your sales representative.

**Checking the Contents of the Package**

Unpack the box and check the contents before using the product. If the product is different from that which you have ordered, if any parts or accessories are missing, or if the product appears to be damaged, contact your sales representative.

**Model and Suffix code**

The 59A main unit has a nameplate affixed to the top of the terminals. Check the model and suffix codes inscribed on the nameplate to confirm that the product received is that which was ordered.

| Model     | Retransmission o/p |            |
|-----------|--------------------|------------|
| 409 - RPM | X                  |            |
|           | 1                  | 4 – 20 mA  |
|           | 2                  | 0 – 20 mA  |
|           | 3                  | 1 – 5 VDC  |
|           | 4                  | 0 – 5 V DC |
|           | 5                  | 0 – 10V DC |

Table 1

**Accessories**

The product is provided with the following accessories according to the model and suffix codes (see the table below). Check that none of them are missing or damaged.

| No | Item name | Part number | Qty | Remarks |
|----|-----------|-------------|-----|---------|
|    |           |             |     |         |
|    |           |             |     |         |

Table 2

damage to the instrument, and signifies that the user must refer to the user’s manual for special instructions. The same symbol is used in the user’s manual on pages that the user needs to refer to, together with the term “WARNING” or “CAUTION.”

**WARNING**

Calls attention to actions or conditions that could cause serious or fatal injury to the user, and indicates precautions that should be taken to prevent such occurrences.

**Symbols Used in This Manual**



This symbol is used on the instrument. It indicates the possibility of injury to the user or

**RPM Indicator Overview:**

Model 409-RPM is a powerful micro-controller based RPM (revolutions per minute) indicator, designed to accept frequency input and features two programmable set points with individual relays. Model 409-RPM accepts frequency input from proxy sensor, and delivers high accurate readings, typically  $\pm 0.015\%$  RPM facilitates plant operator to use in any application. Model 409-RPM is easy to operate and configuration is user friendly. The RPM Indicator has an internal power supply that can provide +24V dc to the Proxy sensor.

**Technical details****1. Display**

**PV:** Red LED 5-digit, character size 0.56".  
**LED** for status indication (Alarm and Tx/Rx)  
**Operation keys:** Escape, Enter, Increment, Decrement.

**2. Input**

**Input:** 0 – 166.666 Hertz Frequency input from Proxy Sensor  
**Range:** 0-10000  
**Accuracy:**  $\pm 0.015\%$  RPM  
**Resolution:** 1 RPM

**3. Alarm**

**Alarm AL1** - Momentary Alarm  
 Condition – high/low/vlow  
 Lamp – on/flash/latch  
 Relay – on/off

**Alarm AL2** - Momentary Alarm  
 Condition – vhigh/high/low  
 Lamp – on/flash/latch  
 Relay – on/off

**4. Re transmission output**

**DC Current:** 0 to 20 mA DC, 4 to 20 mA  
**DC Voltage:** 0 to 10 V DC, 0 to 5V DC, 1 to 5V DC.

Accuracy  $\pm 0.25\%$  of full Span (one at a time factory settable).

**Load Resistance for current O/P:** 600  $\Omega$  or less

**Load Resistance for Voltage O/P:** 2 K $\Omega$  or more

**5. Supply voltage** 85 to 265V AC, 50Hz.  
 18 to 36 V DC .  
 (one at a time factory settable).

**6. Power Consumption** Max. 10VA

**7. Insulation resistance** Between Power supply terminal and ground terminal, 500V DC 50 M $\Omega$ .

**8. Environment**

Ambient: 0 to 55 °C.  
 Humidity: 20 to 95% RH (Non-condensing).

**9. Case**

**Material:** ABS Plastic.  
**Color:** Black.

**10. Mounting method** Panel mounting.

**11. Dimension**

96(W)\*48(H)\*112(D).  
**Panel Cutout:** 92(W)\*46(H)

**12. Weight** 260 grams (Approx.)

**13. Communication**

|                                      |   |
|--------------------------------------|---|
| <b>Communication Interface</b>       | Based on EIA RS-485.                                    |
| <b>Communication method</b>          | Half-duplex communication<br>start stop<br>synchronous. |
| <b>Communication Speed</b>           | 4800/9600/19200/38400bps<br>selectable by key.          |
| <b>Parity</b>                        | None.   |
| <b>Communication Protocol</b>        | Modbus RTU.   |
| <b>Connectable number of unit</b>    | Max.32 unit per host<br>computer.                       |
| <b>Communication error detection</b> | CRC check   |

Table 4.

**14. Contact Input**

1-Channel (Isolated) Non- voltage contact input, maximum reverse voltage 6V, Maximum Forward voltage 50V, Capacity 24V DC, 10mA

**15. Transmitter Power Supply**

24V DC  $\pm 10\%$  @26mA ( $\pm 10\%$  accuracy)

**16. Isolation specification:**

Retransmission output terminal - Isolated from other input/output terminal and internal circuit  
 Relay contact output terminal/RS-485  
 communication terminal/Power supply

**Basic Operation**

**1. Overview of Display Switching and Operation keys**  
**1.1. Keyboard and Operation**

There are four keys for operation of the instruments. For understanding the operation first of all understand the functionality of keys as shown in Fig.1.

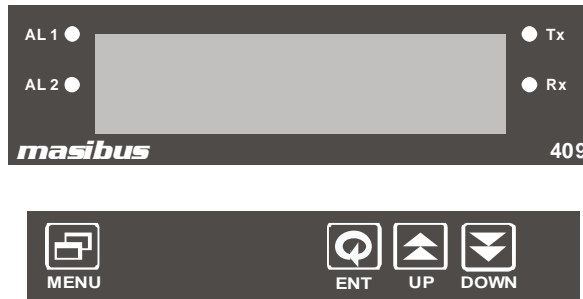

Fig.1.

**MENU key** : It is used to come out from the main or sub menu.

**ENTER key** : It is used to select the desired parameter in various operating mode. After setting the data to proper value, by increment or decrement key, it is used to enter the value of the selected parameter in memory.

**UP key** : It is used to increment the parameter for selection. Value of parameter can be incremented by pressing this key. If the key is pressed continuously for more than 10 counts change, the rate of increment will be made faster. This facility is to allow faster data change for higher values.

**DOWN key** : It is used to decrement the parameter for selection. Value of parameter can be decremented by pressing this key. If the key is pressed continuously for more than 10 counts change, the rate of decrement will be made faster. This facility is to allow faster data change for higher values.

**1.2. Password**

Display indicates “PASS” on display by pressing key (UP & DOWN keys simultaneously).

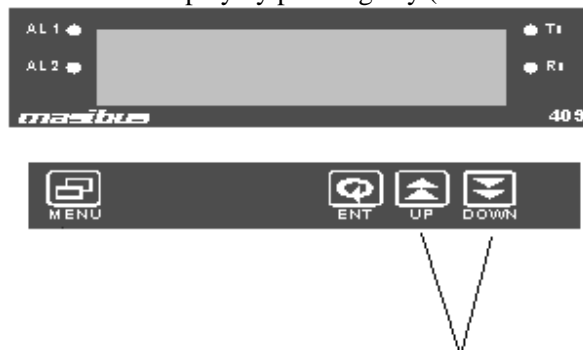

Fig.2.

This is User settable password. It can be any value between 1 to 9999. This password is to be entered each time user needs to change any parameter/value. User can set his own password as per his choice to avoid excess of the previous stored data in the instrument.



When user presses UP & DOWN keys simultaneously as shown in Fig. 2. Display shows “PASS”; press ENTER key and entered the previously stored value of password using UP, DOWN keys. The functioning of the keys is as follow.

- DOWN key** : Is used to decrement the value. Value can be decremented up to minimum value 0.
- UP key** : Is used to increment the value. Value can be incremented up to maximum value 9999.
- ENTER key** : Is used to store the set value as password.
- MENU key** : Is used to come out from the menu.

If password entered is of correct value it will display “CHANG”, else it will display “FAIL”. If user doesn’t want to change the previously stored value of password press “MENU” key it will take the user in to main menu. Display will show “Zero” in the main menu. To change the values of previously stored password press ENTER key when display shows “CHANG”. Display will show “0”. User can increment the value of digit using UP key and decrement the digit using DOWN key. Once user set the value and presses the ENTER key display stops blinking indicates that value of password has been changed and display shows message “0” now, again pressing MENU key user will be in the main menu. Display shows “Zero” that is very first menu message in main menu.

**1.3. Operation in main menu**

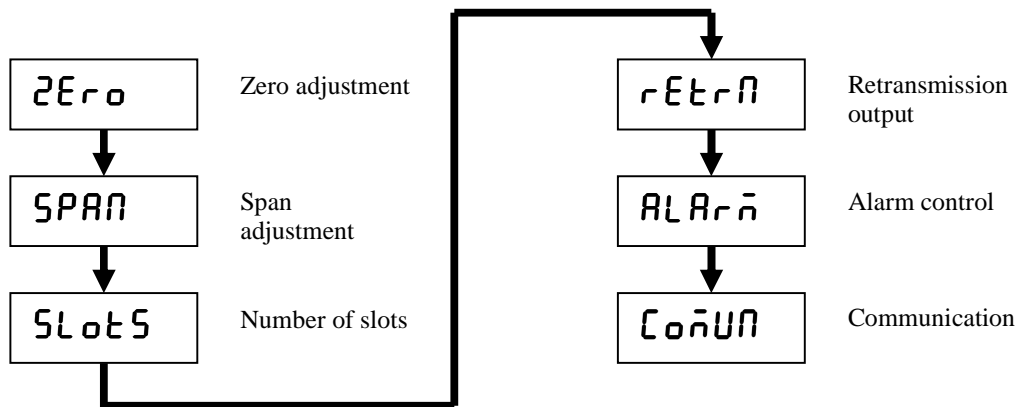

Fig. 3.

As shown in above Fig.3 by pressing UP key in incremental (from message “Zero”) display message will be as indicated by arrow. The last message will be “Communication” and even after user presses UP key, message will not change. Similarly from message “Communication” by pressing DOWN key in incremental display message will be reversed from “Communication” to “Zero”. The last message will be “Zero” and even after user presses DOWN key, message will not change. To enter in to the submenu from main menu press ENTER key.

**1.4. Zero & Span setting**

This setting is used to specify minimum and maximum range of factory default value of zero is 0 and span value is 10000.

When display shows “ZEro”/ “SPAN” press ENTER key to change value. Display will show value of zero/span, user can change the value using UP/DOWN keys. To store the value in memory press ENTER key, display will stop flashing. To come out from the submenu press MENU key, display will be again “ZEro”/ “SPAN”.

**Note:** User cannot enter zero value greater than span or span value less than zero.

**1.5. Slots setting**

This setting is used to the number of slots per revolution.

When display shows “SlotS” press ENTER key to change value. Display will show value from 1 to 60, user can change the value using UP/DOWN keys. To store the value in memory press ENTER key, display will stop flashing. To come out from the submenu press MENU key, display will be again “SlotS”. User can enter maximum 60 slots.

**1.6. Retransmission**

Press ENTER key to enter in to the submenu of retransmission when display shows “rEt rñ”. The submenus of “rEt rñ” are as shown in following Fig.4.

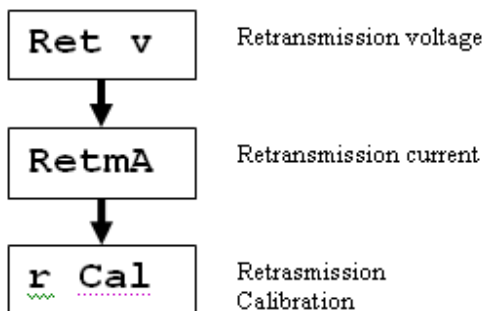

Fig.4

**1.6.1. Retransmission voltage**

Press ENTER key to enter in to the submenu of retransmission voltage when display shows “rEt v”. The submenus of “rEt v” are as shown in following Fig.5.

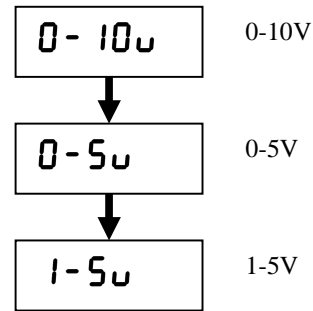

Fig.5

When display shows “rEt v” and user presses ENTER key display can be either of “0-10u”, “0-5u”, or “1-5u” depending up on previously selected logic.

As shown in above Fig.8 by pressing UP key in incremental (from message “0-10u”) display message will be as indicated by arrow. The last message will be “1-5u” and even after user presses UP key, message will not change.

Similarly from message “1-5u” by pressing DOWN key in incremental display message will be reversed from “1-5u” to “0-10u”. The last message will be “0-10u” and even after user presses DOWN key, message will not change. To store the value in memory press ENTER key, display will stop flashing. To come out from the submenu press MENU key, display will be again “rEt v”.

**1.6.2. Retransmission Current**

The submenus of “rEt rñ” are as shown in following Fig.6.

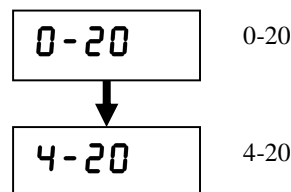

Fig.6.

When display shows “rEtñA” and user presses ENTER key display can be either of “0-20” or “4-20” depending up on previously selected logic.If display shows “0-20” then by pressing UP key display changes to “4-20” and even after user presses UP key last display will be “4-20”. Similarly, if display shows “4-20” then by pressing DOWN key display changes to “0-20” and even after user presses DOWN key last display will be “0-20”. For selection of specific logic i.e. “0-20” or “4-20” press ENTER key, display will stop flashing which indicates that the logic has been selected. To come out from submenus i.e. “0-20” or “4-20” press MENU key display will be “rEtñA”.

**1.6.3. Retransmission calibration**

Press ENTER key to enter in to the submenu of retransmission calibration when display shows “r [AL”. The submenus of “r [AL” are as shown in following Fig.7.

**1.7. Alarm**

Press ENTER key to enter in to the submenu of alarm when display shows “ALArñ”. The submenus of “ALArñ” are as shown in following Fig.8.

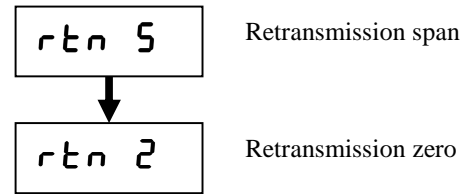

Fig.7

When display shows “rEtñ 5”/ “rEtñ 2” press ENTER key to change value. Display will show value, user can change the value using UP/DOWN keys. To come out from the submenu press MENU key, display will be again “rEtñ 5”/“rEtñ 2”.

**Note:** This is common for calibration of both voltage and current output.

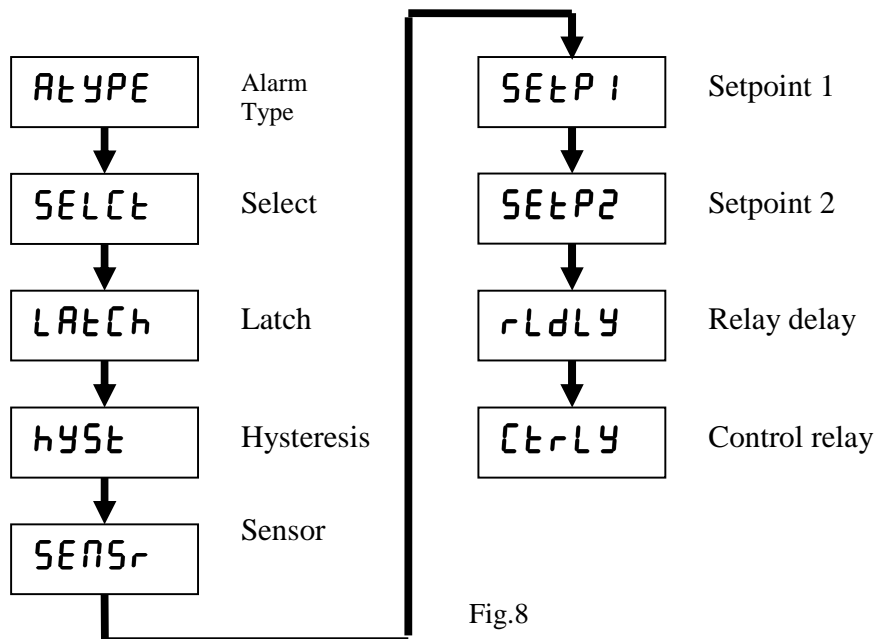

Fig.8

**1.7.1. Alarm type**

The submenus of “*ALTYPE*” are as shown in following Fig.9.

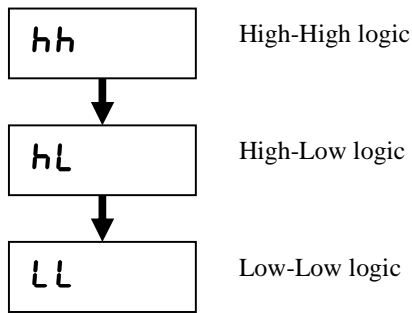

Fig.9

When display shows “*ALTYPE*” and user presses ENTER key display can be either of “*hh*,” “*hL*”, or “*LL*” depending up on previously selected logic.

As shown in above Fig.12 by pressing UP key in incremental (from message “*hh*”) display message will be as indicated by arrow. The last message will be “*LL*” and even after user presses UP key, message will not change. Similarly from message “*LL*” by pressing DOWN key in incremental display message will be reversed from “*LL*” to “*hh*”. The last message will be “*hh*” and even after user presses DOWN key, message will not change. To store the value in memory press ENTER key, display will stop flashing. To come out from the submenu press MENU key, display will be again “*ALTYPE*”.

**1.7.2. Select**

The submenus of “*SELECT*” are as shown in following Fig.10.

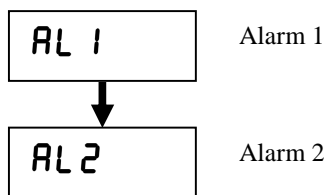

Fig.10

As shown in Fig.10 by pressing UP key in incremental (from message “*AL 1*”) display message will be as indicated by arrow. The last message will be “*AL 2*” and even after user presses UP key, message will not change. Similarly from message “*AL 2*” by pressing DOWN key in incremental

display message will be reversed from “*AL 2*” to “*AL 1*”. The last message will be “*AL 1*” and even after user presses DOWN key, message will not change. To come out from the submenu press MENU key, display will be again “*SELECT*”. Submenus of “*AL 1*” and “*AL 2*” are as under. This is used to select the operation of individual relays.

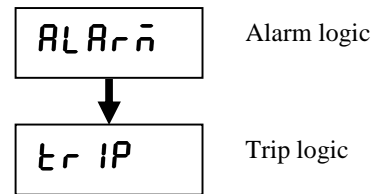

Fig.11

When display shows either “*AL 1*” or “*AL 2*” and user presses ENTER key display message will be either “*AL AL r n*” or “*tr IP*” depending up on previously selected logic.

If display shows “*AL AL r n*” then by pressing UP key display changes to “*tr IP*” and even after user presses UP key last display will be “*tr IP*”. Similarly, if display shows “*tr IP*” then by pressing DOWN key display changes to “*AL AL r n*” and even after user presses DOWN key last display will be “*AL AL r n*”. For selection of specific logic i.e. “*AL AL r n*” or “*tr IP*” press ENTER key ,display will stop flashing indicates that logic has been selected. To come out from submenus i.e. “*AL AL r n*” or “*tr IP*” press MENU key display will be “*AL 1*” or “*AL 2*”, depending up on alarm type selected.

**1.7.3. Latch**

The submenus of “*LATCH*” are as shown in following Fig12.

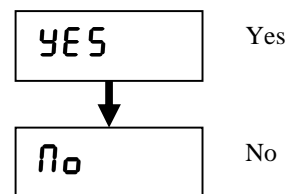

Fig.12

This indicates that whether alarm is with latch (“*YES*”) or without latch logic (“*No*”). When display shows “*LATCH*” and user presses ENTER

key display message will be either “4E5” or “no” depending up on previously selected logic.

If display shows “4E5” then by pressing UP key display changes to “no” and even after user presses UP key last display will be “no”. Similarly, if display shows “no” then by pressing DOWN key display changes to “4E5” and even after user presses DOWN key last display will be “4E5”. For selection of specific logic i.e. “4E5” or “no” press ENTER key ,display will stop flashing indicates that logic has been selected. To come out from submenus i.e. “4E5” or “no” press MENU key display will be “L R L Y”. alarm type selected.

**1.7.4. Hysteresis**

Hysteresis value is common for both alarms. When display shows “h45t” press ENTER key to enter/alter the value of hysteresis.Display will show previously entered value of hysteresis .Use UP key to increase the value and DOWN key to decrease the value of hysteresis. Value of hysteresis can vary from 0(Min)-255(Max),press ENTER key to store the value in memory. Display will stop flashing when user presses ENTER key indicates that value has been stored in memory.

Press MENU key to come out from the submenu of hysteresis, display will be “h45t”.

**1.7.5. Set point 1/ Set point 2**

When display shows “5E t P 1” or “5E t P 2” press ENTER key to enter/alter the value of set point. Display will show previously entered value of set point .Use UP key to increase the value and DOWN key to decrease the value of set point. Press ENTER key to store the value in memory. Display will stop flashing when user presses ENTER key indicates that value has been stored in memory.

Press MENU key to come out from the submenu of set point 1/set point2, display will be “5E t P 1” or “5E t P 2” depending up on selected set point .

Maximum value of set points may be 10000 and minimum value of set points may be 0.

**Note:** Value of set point 1 will be always less than or equal to set point 2 or set point 2 will be always greater than or equal to set point 1.

**1.7.6. Relay delay**

Relay delay value is common for both alarms. When display shows “r L d L Y” press ENTER key to enter/alter the value of delay. Display will show

previously entered value of delay .Use UP key to increase the value and DOWN key to decrease the value of delay. Value of delay can vary from 0(Min)-9999(Max) in second, press ENTER key to store the value in memory. Display will stop flashing when user presses ENTER key indicates that value has been stored in memory.

Press MENU key to come out from the submenu of delay, display will be “r L d L Y”.

**1.7.7. Control relay**

The submenus of “C t r L Y” are as shown in following Fig.14.

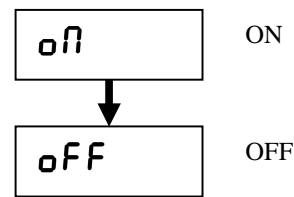

Fig.14

When display shows “C t r L Y” and user presses ENTER key display message will be either “on” or “off” depending up on previously selected logic.

If display shows “on” then by pressing UP key display changes to “off” and even after user presses UP key last display will be “off”. Similarly, if display shows “off” then by pressing DOWN key display changes to “on” and even after user presses DOWN key last display will be “on”. For selection of specific logic i.e. “on” or “off” press ENTER key ,display will stop flashing indicates that logic has been selected. To come out from submenus i.e. “on” or “off” press MENU key display will be “C t r L Y”.

**1.8. Communication**

Press ENTER key to enter in to the submenu of communication when display shows “C o m u n i”.

The submenus of “C o m u n i” are as shown in following Fig.15.

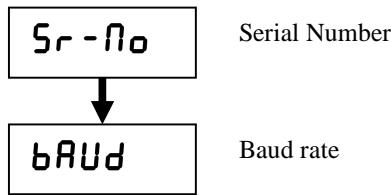

Fig.15

When display shows "СoнУн" and user presses ENTER key display message will be either "Sr - nо" or "bAUd".

If display shows "Sr - nо" then by pressing UP key display changes to "bAUd" and even after user presses UP key last display will be "bAUd". Similarly, if display shows "bAUd" then by pressing DOWN key display changes to "Sr - nо" and even after user presses DOWN key last display will be "Sr - nо". For selection of specific menu i.e. "Sr - nо" or "bAUd" press ENTER key, display will show submenu of corresponding display. To come out from submenus i.e. "Sr - nо" or "bAUd" press MENU key display will be "СoнУн".

### 1.8.1. Serial Number

This value is for slave ID /Node address selection. When display shows "Sr - nо" press ENTER key to enter/alter the value of serial number. Display will show previously entered value of serial number. Use UP key to increase the value and DOWN key to decrease the value. Value of serial number can vary from 1(Min)-247(Max), press ENTER key to store the value in memory. Display will stop flashing when user presses ENTER key; it indicates that value has been stored in memory.

Press MENU key to come out from the submenu of serial no, display will be "Sr - nо".

### 1.8.2. Baud rate

This is used to select baud rate for communication. The submenus for baud rate are as shown in following Fig.16.

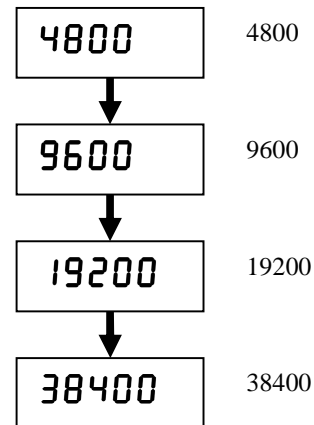

Fig.16

When display shows "bAUd" and user presses ENTER key display can be either of "4800", "9600", "19200", or "38400" depending up on previously selected value.

As shown in Fig.19 by pressing UP key in incremental (from message "4800") display message will be as indicated by arrow. The last message will be "38400" and even after user presses UP key, message will not change. Similarly from message "38400" by pressing DOWN key in incremental display message will be reversed from "38400" to "4800". The last message will be "4800" and even after user presses DOWN key, message will not change. To store the value in memory press ENTER key, display will stop flashing. To come out from the submenu press MENU key, display will be again "bAUd".

---

## Calibration Procedure

### 1.1. Calibration for Retransmission.

The calibration in the instrument is using front panel keys only. Instrument can be calibrated even during installed condition.

Calibration is carried out using following steps.

- 1) Enter in to calibration mode using front panel keys. Display indicates “r E t r” in 5-segment display.
- 2) Select type of output i.e.voltage or current output RET V or RET I then and then it will allow you to enter for calibration of zero and span.
- 3) After selecting type of output Press UP, DOWN key to get a prompt “r E t” and press ENTER key to enter in to calibration.
- 3) Display indicates “r E t 2” for zero calibration; “r E t 5” for span calibration User can enter in to zero/span calibration using UP, DOWN keys (applicable for both voltage/current output).
- 4) To perform zero calibration press ENTER key when display shows “r E t 2”.when user presses ENTER key display will be previously stored counts for voltage output/current output. Retransmission output will be nearly equal to 0 V/0mA depending up on type of selection. If output differs from 0V/0mA vary counts to get desire output.
- 5) Irrespective of value of count try to obtain 0V/0mA at the output and press ENTER key to store calibrated value in memory.

Repeat the above same steps for span calibration here, desired voltage output is 10V and current output is 20mA.

**Note:** calibration for voltage output is required to do in 0-10V range and for current output its 0-20mA range, which incorporates other ranges also. Incase of current output specially to calibrate for zero side vary count in display such that output is greater then zero mA and then bring it down by varying counts it to zero mA.

**Alarm Operation**

**1.1. Alarm type**

HH-high, very high. AL1-high, AL2-very high  
 HL-high, low AL1-low, AL2-high.  
 LL-low, low AL1-very low, AL2-low.  
 This setting is common for all groups.

**1.2. Status of ALARM/TRIP**

It will toggle between ALARM and TRIP depending up on selection in menu. ALARM mode is further subdivided into Alarm with Latch and Alarm without Latch.

TRIP is useful when the relay is used for tripping the plant or device and it is not to be started once again.

**1.3. Latching of ALARM**

This is used for latching of discrete LEDs and relay status when alarm limit is crossed. This option will keep discrete LEDs/Relay latched even after channel has come to normal status until ENTER (ACK) key is pressed. This option can be changed to YES or NO for enabling or disabling respectively. When configurations of Alarms are of TRIP type, these parameters will be skipped from display. The different conditions for the ALARM/TRIP have been mentioned in the following table7, 8, 9, &10.

**1.4.HH Logic**

HH-high, very high. AL1-high, AL2-very high

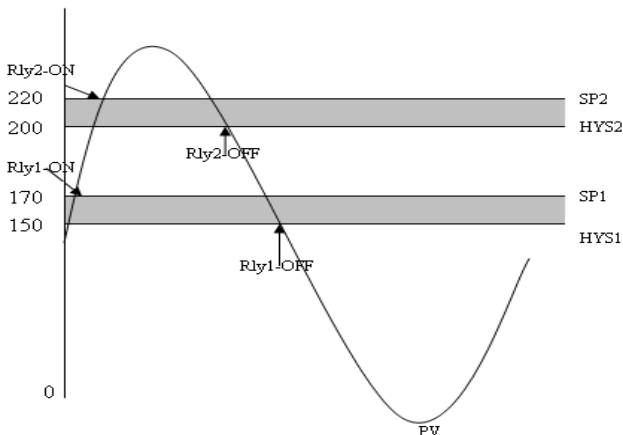

Fig.21

AL1-High, AL2-Very High  
 SP2>SP1

If  $PV > SP1$  but, less then  $SP2 \Rightarrow$  Relay 1- ON, Relay 2-OFF.  
 If  $PV < SP1 - Hyst1 \Rightarrow$  Relay 1-OFF, Relay 2-OFF.

$PV > SP2 \Rightarrow$  Relay1 and Relay2 both are ON.  
 If  $PV < SP2 - Hyst2$  but,  $> SP1 \Rightarrow$  Relay 1-ON, Relay 2-OFF.

Depending up on condition set i.e. Latch Yes/No, Acknowledge Yes/No or Trip refer table7,8,9,&10.

**1.5.HL Logic**

HL-high, low AL1-low, AL2- high.

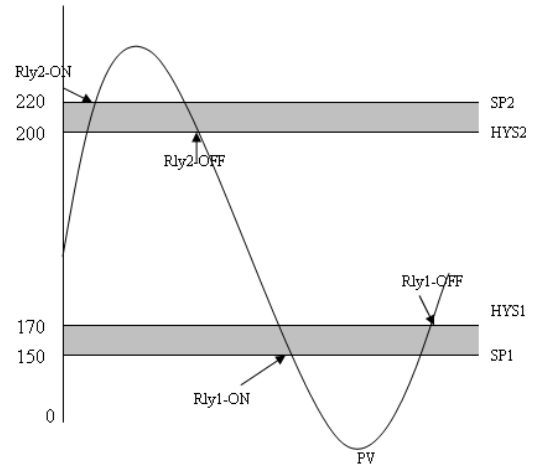

Fig.22

AL1-low, AL2- High  
 SP2>SP1

If  $PV > SP2$  then Relay 2-ON.  
 If  $PV < SP2 - Hyst2 \Rightarrow$  Relay 2-OFF.

$PV < SP1 \Rightarrow$  Relay1 ON.  
 If  $PV > SP1 + Hyst1$  then. Relay 1-OFF.

Depending up on condition set i.e. Latch Yes/No, Acknowledge Yes/No or Trip refer table7, 8, 9 & 10.

**1.6.LL Logic**

LL-low, low AL1-very low, AL2-low.



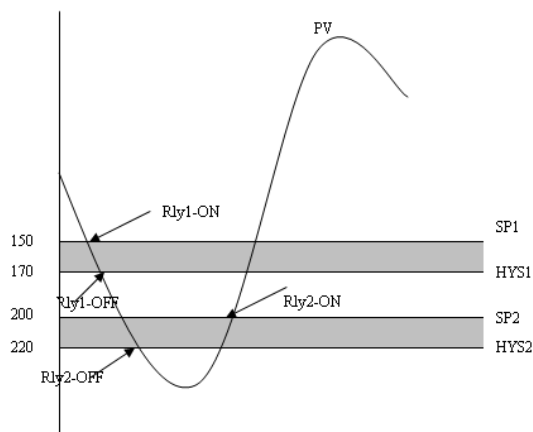

Fig.23

AL1-Low, AL2-Very Low  
 SP2>SP1

If  $PV < SP1$  then  $\Rightarrow$  Relay 1-ON, Relay 2-ON.  
 Relay 1-ON till  $PV > SP1 + HYS1$  after that Relay 1-OFF.

Relay 2-ON till  $PV > SP2 + HYS2$  after that Relay 2- OFF.

Depending up on condition set i.e. Latch Yes/No, Acknowledge Yes/No or Trip refer table 7,8,9&10.

**1.8 Relay Delay**

Relay delay is the parameter used to set the delay (second) in the operation of relays (both 1&2). Minimum value of delay is 0(second) and maximum value 9999 (second) can be configured using keyboard.

**1.9. Control Relay**

Control relay “OFF” then relay will function according to the condition mention in the following tables.

Control relay “ON” then functioning of relay will be just opposite to the condition mention in the table.

Lamp functioning will be as mention in the table i.e. no change in the LED status.

**Alarm AL1 (Momentary Alarm): when in abnormal condition ACK not pressed.**

| Condition |                  |       | Normal | Abnormal | UP    | DOWN  | ACK** | Normal* | ACK*** |
|-----------|------------------|-------|--------|----------|-------|-------|-------|---------|--------|
| High      | Alarm Latch(Yes) | LAMP  | OFF    | FLASH    | FLASH | OFF   |       | FLASH   | OFF    |
|           |                  | RELAY | OFF    | ON       | ON    | OFF   |       | OFF     | OFF    |
|           | Alarm Latch(No)  | LAMP  | OFF    | FLASH    | FLASH | OFF   |       | OFF     | OFF    |
|           |                  | RELAY | OFF    | ON       | ON    | OFF   |       | OFF     | OFF    |
|           | Trip             | LAMP  | OFF    | FLASH    | OFF   | OFF   |       | FLASH   | OFF    |
|           |                  | RELAY | OFF    | ON       | OFF   | OFF   |       | ON      | OFF    |
| Low       | Alarm Latch(Yes) | LAMP  | OFF    | FLASH    | OFF   | FLASH |       | FLASH   | OFF    |
|           |                  | RELAY | OFF    | ON       | OFF   | ON    |       | OFF     | OFF    |
|           | Alarm Latch(No)  | LAMP  | OFF    | FLASH    | OFF   | FLASH |       | OFF     | OFF    |
|           |                  | RELAY | OFF    | ON       | OFF   | ON    |       | OFF     | OFF    |
|           | Trip             | LAMP  | OFF    | FLASH    | OFF   | OFF   |       | FLASH   | OFF    |
|           |                  | RELAY | OFF    | ON       | OFF   | OFF   |       | ON      | OFF    |
| VLOW      | Alarm Latch(Yes) | LAMP  | OFF    | FLASH    | OFF   | FLASH |       | FLASH   | OFF    |
|           |                  | RELAY | OFF    | ON       | OFF   | ON    |       | OFF     | OFF    |
|           | Alarm Latch(No)  | LAMP  | OFF    | FLASH    | OFF   | FLASH |       | OFF     | OFF    |
|           |                  | RELAY | OFF    | ON       | OFF   | ON    |       | OFF     | OFF    |
|           | Trip             | LAMP  | OFF    | FLASH    | OFF   | OFF   |       | FLASH   | OFF    |
|           |                  | RELAY | OFF    | ON       | OFF   | OFF   |       | ON      | OFF    |

Table 7.

**Alarm AL2 (Momentary Alarm): when in abnormal condition ACK not pressed.**

| Condition |                  |       | Normal | Abnormal | UP    | DOWN  | ACK** | Normal* | ACK*** |
|-----------|------------------|-------|--------|----------|-------|-------|-------|---------|--------|
| VHigh     | Alarm Latch(Yes) | LAMP  | OFF    | FLASH    | FLASH | OFF   |       | FLASH   | OFF    |
|           |                  | RELAY | OFF    | ON       | ON    | OFF   |       | OFF     | OFF    |
|           | Alarm Latch(No)  | LAMP  | OFF    | FLASH    | FLASH | OFF   |       | OFF     | OFF    |
|           |                  | RELAY | OFF    | ON       | ON    | OFF   |       | OFF     | OFF    |
|           | Trip             | LAMP  | OFF    | FLASH    | OFF   | OFF   |       | FLASH   | OFF    |
|           |                  | RELAY | OFF    | ON       | OFF   | OFF   |       | ON      | OFF    |
| High      | Alarm Latch(Yes) | LAMP  | OFF    | FLASH    | FLASH | OFF   |       | FLASH   | OFF    |
|           |                  | RELAY | OFF    | ON       | ON    | OFF   |       | OFF     | OFF    |
|           | Alarm Latch(No)  | LAMP  | OFF    | FLASH    | FLASH | OFF   |       | OFF     | OFF    |
|           |                  | RELAY | OFF    | ON       | ON    | OFF   |       | OFF     | OFF    |
|           | Trip             | LAMP  | OFF    | FLASH    | OFF   | OFF   |       | FLASH   | OFF    |
|           |                  | RELAY | OFF    | ON       | OFF   | OFF   |       | ON      | OFF    |
| LOW       | Alarm Latch(Yes) | LAMP  | OFF    | FLASH    | OFF   | FLASH |       | FLASH   | OFF    |
|           |                  | RELAY | OFF    | ON       | OFF   | ON    |       | OFF     | OFF    |
|           | Alarm Latch(No)  | LAMP  | OFF    | FLASH    | OFF   | FLASH |       | OFF     | OFF    |
|           |                  | RELAY | OFF    | ON       | OFF   | ON    |       | OFF     | OFF    |
|           | Trip             | LAMP  | OFF    | FLASH    | OFF   | OFF   |       | FLASH   | OFF    |
|           |                  | RELAY | OFF    | ON       | OFF   | OFF   |       | ON      | OFF    |

Table 8

**Alarm AL1 (Maintained Alarm): when in abnormal condition ACK is pressed.**

| Condition |                  |       | Normal | Abnormal | UP    | DOWN  | ACK**  | Normal* | ACK*** |
|-----------|------------------|-------|--------|----------|-------|-------|--------|---------|--------|
| High      | Alarm Latch(Yes) | LAMP  | OFF    | FLASH    | FLASH | OFF   | STEADY | STEADY  | OFF    |
|           |                  | RELAY | OFF    | ON       | ON    | OFF   | ON     | OFF     | OFF    |
|           | Alarm Latch(No)  | LAMP  | OFF    | FLASH    | FLASH | OFF   | STEADY | OFF     | OFF    |
|           |                  | RELAY | OFF    | ON       | ON    | OFF   | OFF    | OFF     | OFF    |
|           | Trip             | LAMP  | OFF    | FLASH    | OFF   | OFF   | STEADY | STEADY  | OFF    |
|           |                  | RELAY | OFF    | ON       | OFF   | OFF   | ON     | ON      | OFF    |
| Low       | Alarm Latch(Yes) | LAMP  | OFF    | FLASH    | OFF   | FLASH | STEADY | STEADY  | OFF    |
|           |                  | RELAY | OFF    | ON       | OFF   | ON    | ON     | OFF     | OFF    |
|           | Alarm Latch(No)  | LAMP  | OFF    | FLASH    | OFF   | FLASH | STEADY | OFF     | OFF    |
|           |                  | RELAY | OFF    | ON       | OFF   | ON    | OFF    | OFF     | OFF    |
|           | Trip             | LAMP  | OFF    | FLASH    | OFF   | OFF   | STEADY | STEADY  | OFF    |
|           |                  | RELAY | OFF    | ON       | OFF   | OFF   | ON     | ON      | OFF    |
| VLOW      | Alarm Latch(Yes) | LAMP  | OFF    | FLASH    | OFF   | FLASH | STEADY | STEADY  | OFF    |
|           |                  | RELAY | OFF    | ON       | OFF   | ON    | ON     | OFF     | OFF    |
|           | Alarm Latch(No)  | LAMP  | OFF    | FLASH    | OFF   | FLASH | STEADY | OFF     | OFF    |
|           |                  | RELAY | OFF    | ON       | OFF   | ON    | OFF    | OFF     | OFF    |
|           | Trip             | LAMP  | OFF    | FLASH    | OFF   | OFF   | STEADY | STEADY  | OFF    |
|           |                  | RELAY | OFF    | ON       | OFF   | OFF   | ON     | ON      | OFF    |

Table 9

**Alarm AL2 (Maintained Alarm): when in abnormal condition ACK is pressed.**

| Condition |                  |       | Normal | Abnormal | UP    | DOWN  | ACK**  | Normal* | ACK*** |
|-----------|------------------|-------|--------|----------|-------|-------|--------|---------|--------|
| VHigh     | Alarm Latch(Yes) | LAMP  | OFF    | FLASH    | FLASH | OFF   | STEADY | STEADY  | OFF    |
|           |                  | RELAY | OFF    | ON       | ON    | OFF   | ON     | OFF     | OFF    |
|           | Alarm Latch(No)  | LAMP  | OFF    | FLASH    | FLASH | OFF   | STEADY | OFF     | OFF    |
|           |                  | RELAY | OFF    | ON       | ON    | OFF   | OFF    | OFF     | OFF    |
|           | Trip             | LAMP  | OFF    | FLASH    | OFF   | OFF   | STEADY | STEADY  | OFF    |
|           |                  | RELAY | OFF    | ON       | OFF   | OFF   | ON     | ON      | OFF    |
| High      | Alarm Latch(Yes) | LAMP  | OFF    | FLASH    | FLASH | OFF   | STEADY | STEADY  | OFF    |
|           |                  | RELAY | OFF    | ON       | ON    | OFF   | ON     | OFF     | OFF    |
|           | Alarm Latch(No)  | LAMP  | OFF    | FLASH    | FLASH | OFF   | STEADY | OFF     | OFF    |
|           |                  | RELAY | OFF    | ON       | ON    | OFF   | OFF    | OFF     | OFF    |
|           | Trip             | LAMP  | OFF    | FLASH    | OFF   | OFF   | STEADY | STEADY  | OFF    |
|           |                  | RELAY | OFF    | ON       | OFF   | OFF   | ON     | ON      | OFF    |
| LOW       | Alarm Latch(Yes) | LAMP  | OFF    | FLASH    | OFF   | FLASH | STEADY | STEADY  | OFF    |
|           |                  | RELAY | OFF    | ON       | OFF   | ON    | ON     | OFF     | OFF    |
|           | Alarm Latch(No)  | LAMP  | OFF    | FLASH    | OFF   | FLASH | STEADY | OFF     | OFF    |
|           |                  | RELAY | OFF    | ON       | OFF   | ON    | OFF    | OFF     | OFF    |
|           | Trip             | LAMP  | OFF    | FLASH    | OFF   | OFF   | STEADY | STEADY  | OFF    |
|           |                  | RELAY | OFF    | ON       | OFF   | OFF   | ON     | ON      | OFF    |

Table 10

**Notes:** \*means normal condition after abnormal has occurred.

\*\*means ACK pressed in abnormal condition.

\*\*\*means ACK pressed in normal condition after abnormal has occurred.

---

## Installation and Wiring.

### 1. 1.Installation Location

---



#### WARNING

- 1) Devices must be installed by professionally trained personnel.
  - 2) Install devices according to NEC (National Electrical Code: ANSI/NFPA-70).
- 

The instrument should be installed in indoor locations meeting the following conditions:

- **Instrumented panel**

This instrument is designed to be mounted in an instrumented panel. Mount the instrument in a location where its terminals will not inadvertently be touched.

- **Well ventilated locations**

Mount the instrument in well ventilated locations to prevent the instrument's internal temperature from rising. To mount multiple indicating controllers, see the external dimensions/panel cutout dimensions which follow. If mounting other instruments adjacent to the instrument, comply with these panel cutout dimensions to provide sufficient clearance between the instruments.

- **Horizontal location**

Mount the instrument horizontally and ensure that it is level, with no inclination to the right or left.

**Note:** If the instrument is moved from a location with low temperature and low humidity to a place with high temperature and high humidity, or if the temperature changes rapidly, condensation will result. To avoid such a situation, leave the instrument in the new environment under ambient conditions for more than 1 hour prior to using it.

---

Do not mount the instrument in the following locations:

- **Outdoors Locations subject to direct sunlight or close to a heater**

Install the instrument in a location with stable temperatures that remain close to an average temperature of 23°C. Do not mount it in locations subject to direct sunlight or close to a heater. Doing so adversely affects the internal unit.

- **Locations with substantial amounts of oily fumes, steam, dust, or corrosive gases**

The presence of oily fumes, steam, dust, or corrosive gases adversely affects the instrument. Do not mount the instrument in locations subject to any of these substances.

- **Areas near electromagnetic field generating sources**

Do not place magnets or tools that generate magnetism near the instrument. If the instrument is used in locations close to a strong electromagnetic field generating source, the magnetic field may cause measurement errors.

- **Locations where the display is difficult to see**

Mount the instrument in a location where it can be seen as much as possible from the front.

- **Areas close to flammable articles**

Absolutely do not place the instrument directly on flammable surfaces. If such a circumstance is unavoidable and the instrument must be placed close to a flammable item, provide a shield for it made of 1.43 mm thick plated steel or 1.6 mm thick unplated steel with a space of at least 150 mm between it and the instrument on the top, bottom and sides.

- **Areas subject to being splashed with water**

## 1.2. Wiring

### 1.2.1 Wiring Precautions

- 1) Be sure to turn OFF the power supply before wiring to avoid an electric shock. Use a tester or similar device to ensure that no power is being supplied to a cable to be connected.
- 2) As a safety measure, always install a circuit breaker (an IEC 60947-compatible product, 5 A, 100 V or 220 V AC) in an easily accessible location near the instrument. Moreover, provide indication that the switch is a device for turning off the power to the instrument.
- 3) Wiring work must be carried out by a person with basic electrical knowledge and practical experience.

### CAUTION

- 1) Provide electricity from a single-phase power supply. If the power is noisy, install an isolation transformer on the primary side, and use a line filter on the secondary side. When measures against noise are taken, do not install the primary and secondary power cables close to each other.
- 2) If there is a risk of external lightning surges, use a lightning arrester, etc.

1.2.2. Cutout Dimension

Unit:mm.

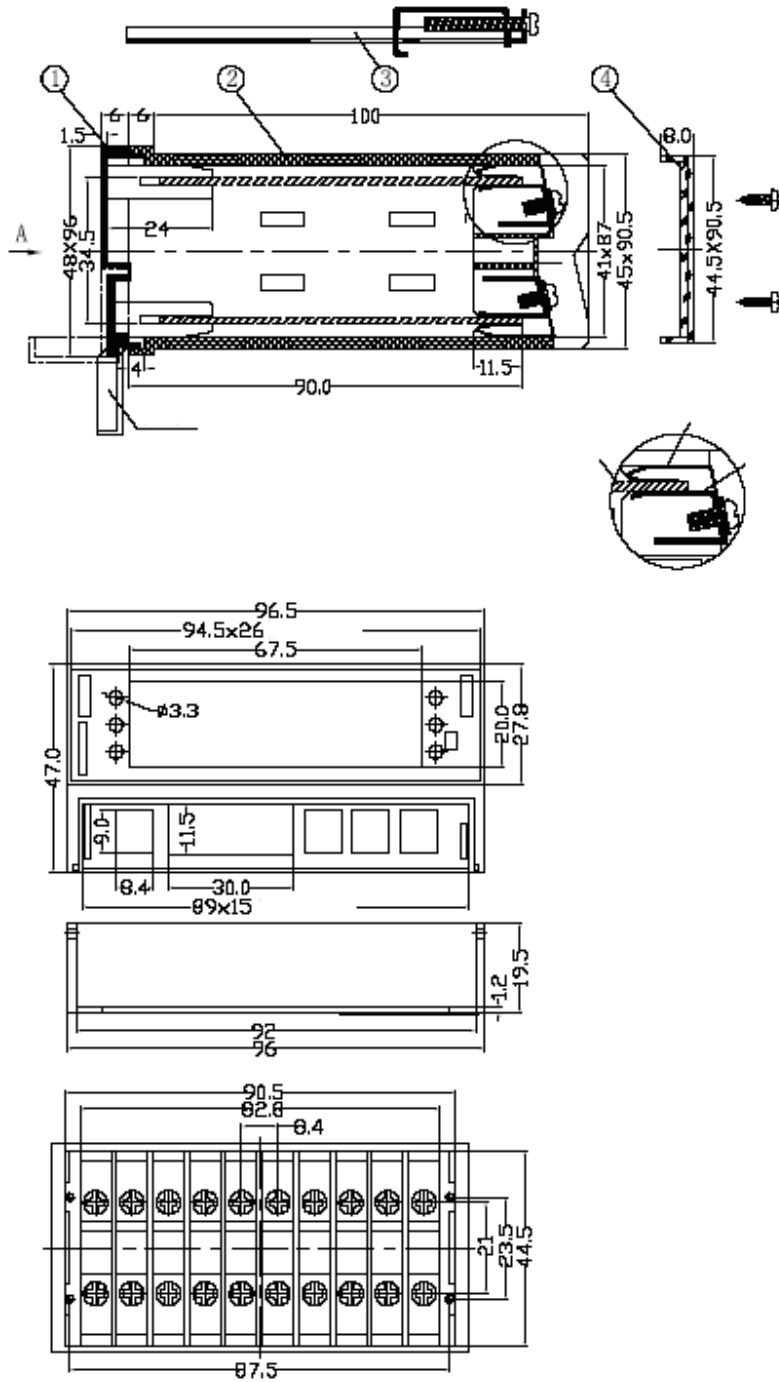

Fig.24

1.2.3. Wiring Diagram.

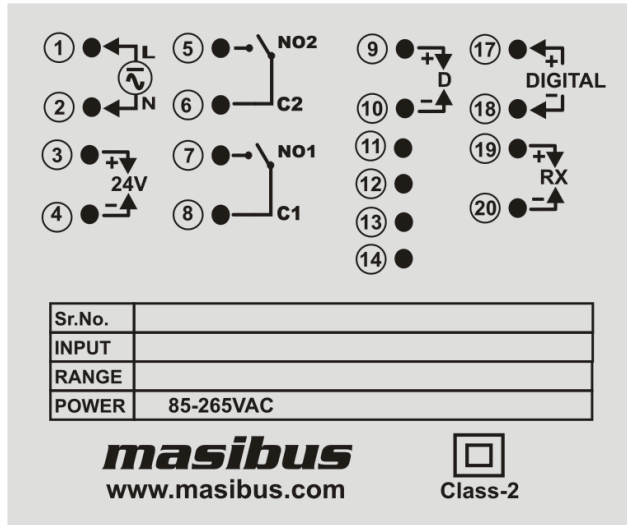

Fig.25

## Parameter

### 1.1. Modbus Parameters.

| Sr.No | Parameter         | Absolute address | Type             | Minimum value | Maximum Value | Access Type |
|-------|-------------------|------------------|------------------|---------------|---------------|-------------|
| 1     | *Relay status1    | 1                | Bit              | 0             | 1             | R/W         |
| 2     | *Relay status2    | 2                | Bit              | 0             | 1             | R           |
| 3     | *Alarm status1    | 1001             | Bit              | 0             | 1             | R           |
| 4     | *Alarm status2    | 1002             | Bit              | 0             | 1             | R           |
| 5     | Rpm               | 30001            | Integer          |               |               | R           |
| 6     | Zero display      | 40001            | Integer          |               |               | R/W         |
| 7     | Span display      | 40002            | Integer          |               |               | R/W         |
| 8     | Set point 1       | 40003            | Integer          |               |               | R/W         |
| 9     | Set point 2       | 40004            | Integer          |               |               | R/W         |
| 10    | Relay delay       | 40005            | Integer          | 0             | 9999          | R/W         |
| 11    | Slots             | 40006            | Unsigned Integer | 1             | 60            | R/W         |
| 12    | Unused            | 40007            | -                | -             | -             | -           |
| 13    | Unused            | 40008            | -                | -             | -             | -           |
| 14    | Hysteresis        | 40009            | Unsigned char    | 0             | 255           | R/W         |
| 15    | Serial number     | 40010            | Unsigned Char    | 1             | 247           | R/W         |
| 16    | *Baud rate        | 40011            | Unsigned char    | 0             | 3             | R/W         |
| 17    | *Alarm logic type | 40012            | Unsigned char    | 0             | 2             | R/W         |
| 18    | *Alarm 1          | 40013            | Unsigned char    | 0             | 1             | R/W         |
| 19    | *Alarm 2          | 40014            | Unsigned char    | 0             | 1             | R/W         |
| 20    | *Alarm Latch      | 40015            | Unsigned char    | 0             | 1             | R/W         |
| 21    | * Alarm sensor    | 40016            | Unsigned char    | 0             | 1             | R/W         |
| 22    | *Relay control    | 40017            | Unsigned char    | 0             | 1             | R/W         |
| 23    | Password          | 40018            | Unsigned integer | 1             | 9999          | R/W         |

Table 11

\*Relay status1, \*Relay status2 it gives status of LED. Relay status1 can be used to acknowledge using function code-5.Address 3-16 for future use only.

\*Alarm status1, \*Alarm status2 gives status of abnormal condition only. Address 1003-1016 for future use only.

\*Input type: 0 = Etc,1 = Jtc,2 = Ktc,3 = Ttc,4 = Btc,5 = Rtc,6 = Stc,7= pt-100, 8 = 0-400Ω,9 = 0-6000Ω, 10 = ±10V,11 = 0-10V,12 = 0-5V,13 = 1-5V,14 = 0-2V,15 = 0.4-2V,16 = -10-20mV,17 = ±75mV,18 = 0-75mV;\*Baud rate: 0 = 4800, 1 = 9600, 2 = 19200, 3 = 38400.

\*Alarm Latch: 0 = YES, 1 = NO;\* Alarm sensor: 0 =UP, 1=DOWN.

\*Relay control: 0 = ON, 1=OFF.\*Alarm logic type: 0 = HH, 1 = HL, 2 = LL.

\*Alarm 1: 0 = Alarm, 1 = Trip.\*Alarm 2: 0 = Alarm, 1 = Trip.

Values when OPEN :- 32766, UNDER: - 32768, OVER: - 32767, doPEN: -32765.

\*Decimal point: 4=0, 3= .0, 2=.00, 1=.000, 0=.0000



## 1.2. Menu Parameters

| Parameter | Name   | Setting and Display range | Unit   | Factory default value | Display and setting condition for controller mode |
|-----------|--|---------------------------|--------|-----------------------|---|
| PA55      | Pass word                                    | 0001 – 9999               | Engg.  |                       | R/W   |
| CHANG     | Change of password                           | 0001 – 9999               | Engg   | Undefined             | R/W   |
| OP        | Message indicates password change correctly  |                           |        | Undefined             | R   |
| FAIL      | Message indicates password entered is wrong. |                           |        |                       | R   |
| SLOTS     | Number of slots                              | 1-60                      | Slots  | 1                     | R/W   |
| ZERO      | Zero enter                                   |                           | RPM    | 0                     | R/W   |
| SPAN      | Span enter                                   |                           | RPM    | 10000                 | R/W   |
| ALARM     | Alarm Logic                                  |                           |        |                       |   |
| ATYPE     | Alarm type                                   |                           |        |                       |   |
| HH        | High-High logic                              |                           |        |                       |   |
| HL        | High-Low logic                               |                           |        |                       |   |
| LL        | Low-Low logic                                |                           |        |                       |   |
| SELECT    | Selection for Alarm 1 & 2.                   |                           |        |                       |   |
| AL1       | Alarm 1                                      |                           |        |                       |   |
| AL2       | Alarm 2                                      |                           |        |                       |   |
| ALARM     | Alarm selection                              |                           |        |                       |   |
| TRIP      | Trip selection                               |                           |        |                       |   |
| LATCH     | Latch status                                 |                           |        |                       |   |
| YES       | Latch Yes                                    |                           |        |                       |   |
| NO        | Latch No                                     |                           |        |                       |   |
| HYST      | Hysteresis                                   | 0-255                     | RPM    |                       | R/W   |
| SENSOR    | Sensor logic selection                       |                           |        |                       |   |
| UP        | Up scale logic                               |                           |        |                       |   |
| DOWN      | Down scale logic                             |                           |        |                       |   |
| SETP1     | Set point 1 for Alarm 1                      |                           |        |                       | R/W   |
| SETP2     | Set point 2 for Alarm 2                      |                           |        |                       | R/W   |
| RLDLY     | Relay delay                                  | 0-9999                    | second |                       | R/W   |
| CTRL      | Control relay logic                          |                           |        |                       |   |
| ON        | On control relay                             |                           |        |                       |   |
| OFF       | OFF control relay                            |                           |        |                       |   |
| CONUN     | 485-Communication                            |                           |        |                       |   |
| SR-NO     | Serial number for Modbus.                    | 1-247                     | Engg   |                       | R/W   |

|         |                            |  |  |  |     |
|---------|----------------------------|--|--|--|-----|
| 6A00    | Baud rate selection        |  |  |  | R/W |
| 4800    | 4800                       |  |  |  | R/W |
| 9600    | 9600                       |  |  |  | R/W |
| 19200   | 19200                      |  |  |  | R/W |
| 38400   | 38400                      |  |  |  | R/W |
| rEt r n | Retransmission             |  |  |  |     |
| rEt u   | Retransmission voltage     |  |  |  |     |
| 0-10u   | Output 0-10V               |  |  |  |     |
| 0-5u    | Output 0-5V                |  |  |  |     |
| 1-5u    | Output 1-5V                |  |  |  |     |
| rEt nA  | Retransmission current     |  |  |  |     |
| 0-20    | Output 0-20mA              |  |  |  |     |
| 4-20    | Output 4-20mA              |  |  |  |     |
| r cAL   | Retransmission calibration |  |  |  |     |
| rEn 5   | Retransmission span        |  |  |  |     |
| rEn 2   | Retransmission zero        |  |  |  |     |

Table 12

### 1.3. Retransmission output during OVER

| 0-20 mA O/P  |              | 4-20 mA O/P  |              |
|--------------|--------------|--------------|--------------|
| UP Scale O/P | DW Scale O/P | UP Scale O/P | DW Scale O/P |
| 21.00        | 0.0          | 20.8         | 3.2          |

Table 13-A

| 0-10 V O/P   |              | 0-5 V O/P    |              | 1-5 V O/P    |              |
|--------------|--------------|--------------|--------------|--------------|--------------|
| UP Scale O/P | DW Scale O/P | UP Scale O/P | DW Scale O/P | UP Scale O/P | DW Scale O/P |
| 10.50        | 0.0          | 5.25         | 0.0          | 5.20         | 0.80         |

Table 13-B

OVER will be displayed when value is beyond 5% of span-zero.

Above mention value in the table will come only after calibration for specific o/p type i.e. Voltage/Current.

## 1.4. Used Modbus function descriptions.

### 1.4.1 Read coil status (01).

**Description :** Reads the ON/OFF status of discrete outputs (0X references, coils) in the slave. Broadcast is not supported.

**Query:** The query message specifies the starting coil and quantity of coils to be read. Coils are addressed starting at zero: coils 1–16 are addressed as 0–15. Here is an example of a request to read coils 20–56 from slave device 17:

#### Example

Field Name (Hex)

|                          |    |
|--------------------------|----|
| Slave Address            | 11 |
| Function                 | 01 |
| Starting Address Hi      | 00 |
| Starting Address Lo      | 13 |
| No. of Points Hi         | 00 |
| No. of Points Lo         | 25 |
| Error Check (LRC or CRC) | —  |

**Response:** The coil status in the response message is packed as one coil per bit of the data field. Status is indicated as: 1 = ON; 0 = OFF. The LSB of the first data byte contains the coil addressed in the query. The other coils follow toward the high order end of this byte, and from ‘low order to high order’ in subsequent bytes. If the returned coil quantity is not a multiple of eight, the remaining bits in the final data byte will be padded with zeros (toward the high order end of the byte). The Byte Count field specifies the quantity of complete bytes of data. Here is an example of a response to the query on the opposite page:

#### Example

Field Name (Hex)

|                          |    |
|--------------------------|----|
| Slave Address            | 11 |
| Function                 | 01 |
| Byte Count               | 05 |
| Data (Coils 27–20)       | CD |
| Data (Coils 35–28)       | 6B |
| Data (Coils 43–36)       | B2 |
| Data (Coils 51–44)       | 0E |
| Data (Coils 56–52)       | 1B |
| Error Check (LRC or CRC) | —  |

The status of coils 27–20 is shown as the byte value CD hex, or binary 1100 1101. Coil 27 is the MSB of this byte, and coil 20 is the LSB. Left to right, the status of coils 27 through 20 is: ON–ON–OFF–OFF–ON–ON–OFF–ON. By convention, bits within a byte are shown with the MSB to the left, and the LSB to the right. Thus the coils in the first byte are ‘27 through 20’, from left to right. The next byte has coils ‘35 through 28’, left to right. As the bits are transmitted serially, they flow from LSB to MSB: 20 . . . 27, 28 . . . 35, and so on.

In the last data byte, the status of coils 56–52 is shown as the byte value 1B hex, or binary 0001 1011. Coil 56 is in the fourth bit position from the left, and coil 52 is the LSB of this byte. The status of coils 56 through 52 is: ON–ON–OFF–ON–ON. Note how the three remaining bits (toward the high order end) are zero-filled.

### 1.4.2. Read Input Status (02)

**Description:** Reads the ON/OFF status of discrete inputs (1X references) in the slave. Broadcast is not supported.

**Query:** The query message specifies the starting input and quantity of inputs to be read. Inputs are addressed starting at zero: inputs 1–16 are addressed as 0–15. Here is an example of a request to read inputs 10197–10218 from slave device 17:

Example

|                          |    |
|--------------------------|----|
| Field Name (Hex)         |    |
| Slave Address            | 11 |
| Function                 | 02 |
| Starting Address Hi      | 00 |
| Starting Address Lo      | C4 |
| No. of Points Hi         | 00 |
| No. of Points Lo         | 16 |
| Error Check (LRC or CRC) | —  |

**Response:** The input status in the response message is packed as one input per bit of the data field. Status is indicated as: 1 = ON; 0 = OFF. The LSB of the first data byte contains the input addressed in the query. The other inputs follow toward the high order end of this byte, and from ‘low order to high order’ in subsequent bytes. If the returned input quantity is not a multiple of eight, the remaining bits in the final data byte will be padded with zeros (toward the high order end of the byte). The Byte Count field specifies the quantity of complete bytes of data.

**Example**

|                           |    |
|---------------------------|----|
| Field Name (Hex)          |    |
| Slave Address             | 11 |
| Function                  | 02 |
| Byte Count                | 03 |
| Data (Inputs 10204–10197) | AC |
| Data (Inputs 10212–10205) | DB |
| Data (Inputs 10218–10213) | 35 |
| Error Check (LRC or CRC)  | —  |

The status of inputs 10204–10197 is shown as the byte value AC hex, or binary 1010 1100. Input 10204 is the MSB of this byte, and input 10197 is the LSB. Left to right, the status of inputs 10204 through 10197 is: ON–OFF–ON–OFF–ON–ON–OFF–OFF. The status of inputs 10218–10213 is shown as the byte value 35 hex, or binary 0011 0101. Input 10218 is in the third bit position from the left, and input 10213 is the LSB. The status of inputs 10218 through 10213 is: ON–ON–OFF–ON–OFF–ON. Note how the two remaining bits (toward the high order end) are zero-filled.

### 1.4.3. Read Holding register (03)

**Description:** Reads the binary contents of holding registers (4X references) in the slave. Broadcast is not supported.

**Query:** The query message specifies the starting register and quantity of registers to be read. Registers are addressed starting at zero: registers 1–16 are addressed as 0–15. Here is an example of a request to read registers 40108–40110 from slave device 17:

**Example**

|                          |    |
|--------------------------|----|
| Field Name (Hex)         |    |
| Slave Address            | 11 |
| Function                 | 03 |
| Starting Address Hi      | 00 |
| Starting Address Lo      | 6B |
| No. of Points Hi         | 00 |
| No. of Points Lo         | 03 |
| Error Check (LRC or CRC) | —  |

**Response:** The register data in the response message are packed as two bytes per register, with the binary contents right justified within each byte. For each register, the first byte contains the high order bits and the second contains the low order bits. Data is scanned in the slave at the rate of 125 registers per scan for 984–X8Xcontrollers (984–685, etc), and at the rate of 32 registers per scan for all other controllers. The response is returned when the data is completely assembled.

**Example**

|                          |    |
|--------------------------|----|
| Field Name (Hex)         |    |
| Slave Address            | 11 |
| Function                 | 03 |
| Byte Count               | 06 |
| Data Hi (Register 40108) | 02 |
| Data Lo (Register 40108) | 2B |
| Data Hi (Register 40109) | 00 |
| Data Lo (Register 40109) | 00 |
| Data Hi (Register 40110) | 00 |
| Data Lo (Register 40110) | 64 |
| Error Check (LRC or CRC) | —  |

The contents of register 40108 are shown as the two byte values of 02 2B hex, or 555 decimal. The contents of registers 40109–40110 are 00 00 and 00 64 hex, or 0 and 100 decimal.

**1.4.4. Read Input register (04)**

**Description:** Reads the binary contents of input registers (3X references) in the slave. Broadcast is not supported.

**Query:** The query message specifies the starting register and quantity of registers to be read. Registers are addressed starting at zero: registers 1–16 are addressed as 0–15. Here is an example of a request to read register 30009 from slave device 17:

**Example**

|                          |    |
|--------------------------|----|
| Field Name (Hex)         |    |
| Slave Address            | 11 |
| Function                 | 04 |
| Starting Address Hi      | 00 |
| Starting Address Lo      | 08 |
| No. of Points Hi         | 00 |
| No. of Points Lo         | 01 |
| Error Check (LRC or CRC) | —  |

**Response:** The register data in the response message are packed as two bytes per register, with the binary contents right justified within each byte. For each register, the first byte contains the high order bits and the second contains the low order bits. Data is scanned in the slave at the rate of 125 registers per scan for 984–X8X controllers (984–685, etc), and at the rate of 32 registers per scan for all other controllers. The response is returned when the data is completely assembled.

**Example**

| Field Name (Hex)         |    |
|--------------------------|----|
| Slave Address            | 11 |
| Function                 | 04 |
| Byte Count               | 02 |
| Data Hi (Register 30009) | 00 |
| Data Lo (Register 30009) | 0A |
| Error Check (LRC or CRC) | —  |

The contents of register 30009 are shown as the two byte values of 00 0A hex, or 10 decimal.

### 1.4.5 Force Single Coil (05)

**Description:** Forces a single coil (0X reference) to either ON or OFF. When broadcast the function forces the same coil reference in all attached slaves.

**Query:** The query message specifies the coil reference to be forced. Coils are addressed starting at zero: coil 1 is addressed as 0. The requested ON/OFF state is specified by a constant in the query data field. A value of FF 00 hex requests the coil to be ON. A value of 00 00 requests it to be OFF. All other values are illegal and will not affect the coil. Here is an example of a request to force coil 173 ON in slave device 17:

**Example**

| Field Name (Hex)         |    |
|--------------------------|----|
| Slave Address            | 11 |
| Function                 | 05 |
| Coil Address Hi          | 00 |
| Coil Address Lo          | AC |
| Force Data Hi            | FF |
| Force Data Lo            | 00 |
| Error Check (LRC or CRC) | —  |

**Response:** The normal response is an echo of the query, returned after the coil state has been forced. Here is an example of a response to the query on the opposite page:

**Example**

| Field Name (Hex)         |    |
|--------------------------|----|
| Slave Address            | 11 |
| Function                 | 05 |
| Coil Address Hi          | 00 |
| Coil Address Lo          | AC |
| Force Data Hi            | FF |
| Force Data Lo            | 00 |
| Error Check (LRC or CRC) | —  |

### 1.4.6 Preset Multiple Registers (16)

**Description:** Presets values into a sequence of holding registers (4X references). When broadcast, the function presets the same register references in all attached slaves.

**Query:** The query message specifies the register references to be preset. Registers are addressed starting at zero: register 1 is addressed as 0. The requested preset values are specified in the query data field. All other controllers use 16-bit values. Data is packed as two bytes per register. Here is an example of a request to preset two registers starting at 40002 to 00 0A and 01 02 hex, in slave device 17:

**Example**

| Field Name (Hex)         |    |
|--------------------------|----|
| Slave Address            | 11 |
| Function                 | 10 |
| Starting Address Hi      | 00 |
| Starting Address Lo      | 01 |
| No. of Registers Hi      | 00 |
| No. of Registers Lo      | 02 |
| Byte Count               | 04 |
| Data Hi                  | 00 |
| Data Lo                  | 0A |
| Data Hi                  | 01 |
| Data Lo                  | 02 |
| Error Check (LRC or CRC) | —  |

**Response** The normal response returns the slave address, function code, starting address, and quantity of registers preset. Here is an example of a response to the query shown above.

**Example**

| Field Name (Hex)         |    |
|--------------------------|----|
| Slave Address            | 11 |
| Function                 | 10 |
| Starting Address Hi      | 00 |
| Starting Address Lo      | 01 |
| No. of Registers Hi      | 00 |
| No. of Registers Lo      | 02 |
| Error Check (LRC or CRC) | —  |

### 1.5. Exception responses for modbus.

The exception response message has two fields that differentiate it from a normal response:

**Function Code Field:** In a normal response, the slave echoes the function code of the original query in the function code field of the response. All function codes have a most-significant bit (MSB) of 0 (their values are all below 80 hexadecimal). In an exception response, the slave sets the MSB of the function code to 1. This makes the function code value in an exception response exactly 80 hexadecimal higher than the value would be for a normal response. With the function code's MSB set, the master's application program can recognize the exception response and can examine the data field for the exception code.

**Data Field:** In a normal response, the slave may return data or statistics in the data field (any information that was requested in the query). In an exception response, the slave returns an exception code in the data field. This defines the slave condition that caused the exception.

Fig.26 shows an example of a master query and slave exception response. The field examples are shown in hexadecimal.

| QUERY |                     |         |
|-------|---------------------|---------|
| Byte  | Contents            | Example |
| 1     | Slave Address       | 0A      |
| 2     | Function            | 01      |
| 3     | Starting Address Hi | 04      |
| 4     | Starting Address Lo | A1      |
| 5     | No. of Coils Hi     | 00      |
| 6     | No. of Coils Lo     | 01      |
| 7     | LRC                 | 4F      |

| EXCEPTION RESPONSE |                |         |
|--------------------|----------------|---------|
| Byte               | Contents       | Example |
| 1                  | Slave Address  | 0A      |
| 2                  | Function       | 81      |
| 3                  | Exception Code | 02      |
| 4                  | LRC            | 73      |

Fig.26.

In this example, the master addresses a query to slave device 10 (0A hex). The function code (01) is for a Read Coil Status operation. It requests the status of the coil at address 1245 (04A1 hex). Note that only that one coil is to be read, as specified by the number of coils field (0001). If the coil address is non-existent in the slave device, the slave will return the exception response with the exception code shown (02). This specifies an illegal data address for the slave. For example, if the slave is a 984–385 with 512 coils, this code would be returned.

### Exception codes

| Code | Name                 | Meaning  |
|------|----------------------|--|
| 01   | ILLEGAL FUNCTION     | The function code received in the query is not an allowable action for the slave. If a Poll Program Complete command was issued, this code indicates that no program function preceded it. |
| 02   | ILLEGAL DATA ADDRESS | The data address received in the query is not an allowable address for the Slave   |
| 03   | ILLEGAL DATA VALUE   | A value contained in the query data field is not an allowable value for the Slave  |

Table 15



# ***masibus***

---

**MASIBUS AUTOMATION AND INSTRUMENTATION (P) LTD.**

**Headquarter:**

**B/30, GIDC Electronics Estate, Sector – 25,  
Gandhinagar-382044, Gujarat, India.**

**Ph : +91-79-23287275 / 79.**

**Fax : +91-79-23287281.**

**E-mail : [sales@masibus.com](mailto:sales@masibus.com)**

**Web : [www.masibus.com](http://www.masibus.com)**

---