

# HART® field temperature transmitter Models TIF50, TIF52

WIKA data sheet TE 62.01



## Applications

- Plant construction
- Process engineering
- General industrial applications
- Oil and gas

## Special features

- Setting of units and measuring range possible on site (only model TIF52)
- Different hazardous area approvals
- The following settings are possible via external software:
  - Duplex sensor, redundant measurement possible
  - Customer-specific characteristic curves programmable



Field temperature transmitter, models TIF50, TIF52

## Description

The TIF series field temperature transmitters, consisting of a rugged field housing, model T32 temperature transmitter and a model DIH display, have been designed for general use in process engineering.

They offer high accuracy, galvanic isolation and excellent protection against electromagnetic influences (EMI). Via HART® protocol, the TIFxx is configurable (interoperable) with a variety of open configuration tools.

In addition to the different sensor types, e.g. sensors in accordance with DIN EN 60751, JIS C1606, DIN 43760, IEC 60584 or DIN 43710, customer-specific sensor characteristics can also be defined, through the input of value pairs (user-defined linearisation).

Through the configuration of a sensor with redundancy (dual sensor), on a sensor failure it will automatically change over to the working sensor.

Furthermore there is the possibility to activate Sensor Drift Detection. With this, an error signal occurs when the magnitude of the temperature difference between Sensor 1 and Sensor 2 exceeds a user-selectable value.

The field temperature transmitter also has additional sophisticated supervisory functionality such as monitoring of the sensor wire resistance and sensor-break detection in accordance with NAMUR NE89 as well as monitoring of the measuring range. Moreover, this transmitter has comprehensive cyclic self-monitoring functionality.

Via the display it is possible to show range alarms as well as MIN and MAX values.

The field temperature transmitter is available in various field-housing variants. Plastic, stainless steel and aluminium can be specified.

It can be mounted directly on a wall. A pipe mounting kit is also available for fitting to pipes with a diameter of 1... 2".

The field temperature transmitters are delivered with a basic configuration or configured according to customer specifications.

## Specifications model TIF5x

### Field temperature transmitter input

Resistance sensor	Max. configurable measuring range <sup>1)</sup>	Standard	$\alpha$ values	Minimum measuring span <sup>14)</sup>	Typical measuring deviation <sup>2)</sup>	Temperature coefficient per °C typical <sup>3)</sup>
Pt100	-200 ... +850 °C	IEC 60751:2008	$\alpha = 0.00385$	10 K or 3.8 $\Omega$ whichever is greater	$\leq \pm 0.12$ °C <sup>5)</sup>	$\leq \pm 0.0094$ °C <sup>6) 7)</sup>
Pt(x) <sup>4)</sup> 10 ... 1000	-200 ... +850 °C	IEC 60751:2008	$\alpha = 0.00385$		$\leq \pm 0.12$ °C <sup>5)</sup>	$\leq \pm 0.0094$ °C <sup>6) 7)</sup>
JPt100	-200 ... +500 °C	JIS C1606:1989	$\alpha = 0.003916$		$\leq \pm 0.12$ °C <sup>5)</sup>	$\leq \pm 0.0094$ °C <sup>6) 7)</sup>
Ni100	-60 ... +250 °C	DIN 43760:1987	$\alpha = 0.00618$		$\leq \pm 0.12$ °C <sup>5)</sup>	$\leq \pm 0.0094$ °C <sup>6) 7)</sup>
Resistance sensor	0 ... 8,370 $\Omega$			4 $\Omega$	$\leq \pm 1.68$ $\Omega$ <sup>8)</sup>	$\leq \pm 0.1584$ $\Omega$ <sup>8)</sup>
Potentiometer <sup>9)</sup>	0 ... 100 %			10 %	$\leq 0.50$ % <sup>10)</sup>	$\leq \pm 0.0100$ % <sup>10)</sup>

Sensor current at the measurement max. 0.3 mA (Pt100)

Connection type 1 sensor 2- /4- /3-wire or 2 sensors 2-wire  
(for further information, please refer to designation of terminal connections)

Max. wire resistance 50  $\Omega$  each wire, 3-/4-wire

Thermocouple	Max. configurable measuring range <sup>1)</sup>	Standard	Minimum measuring span <sup>14)</sup>	Typical measuring deviation <sup>2)</sup>	Temperature coefficient per °C typical <sup>3)</sup>
Type J (Fe-CuNi)	-210 ... +1,200 °C	IEC 60584-1:1995	50 K or 2 mV whichever is greater	$\leq \pm 0.91$ °C <sup>11)</sup>	$\leq \pm 0.0217$ °C <sup>7) 11)</sup>
Type K (NiCr-Ni)	-270 ... +1,372 °C	IEC 60584-1:1995		$\leq \pm 0.98$ °C <sup>11)</sup>	$\leq \pm 0.0238$ °C <sup>7) 11)</sup>
Type L (Fe-CuNi)	-200 ... +900 °C	DIN 43760:1987		$\leq \pm 0.91$ °C <sup>11)</sup>	$\leq \pm 0.0203$ °C <sup>7) 11)</sup>
Type E (NiCr-Cu)	-270 ... +1,000 °C	IEC 60584-1:1995		$\leq \pm 0.91$ °C <sup>11)</sup>	$\leq \pm 0.0224$ °C <sup>7) 11)</sup>
Type N (NiCrSi-NiSi)	-270 ... +1,300 °C	IEC 60584-1:1995		$\leq \pm 1.02$ °C <sup>11)</sup>	$\leq \pm 0.0238$ °C <sup>7) 11)</sup>
Type T (Cu-CuNi)	-270 ... +400 °C	IEC 60584-1:1995		$\leq \pm 0.92$ °C <sup>11)</sup>	$\leq \pm 0.0191$ °C <sup>7) 11)</sup>
Type U (Cu-CuNi)	-200 ... +600 °C	DIN 43710:1985		$\leq \pm 0.92$ °C <sup>11)</sup>	$\leq \pm 0.0191$ °C <sup>7) 11)</sup>
Type R (PtRh-Pt)	-50 ... +1,768 °C	IEC 60584-1:1995	150 K	$\leq \pm 1.66$ °C <sup>11)</sup>	$\leq \pm 0.0338$ °C <sup>7) 11)</sup>
Type S (PtRh-Pt)	-50 ... +1,768 °C	IEC 60584-1:1995	150 K	$\leq \pm 1.66$ °C <sup>11)</sup>	$\leq \pm 0.0338$ °C <sup>7) 11)</sup>
Type B (PtRh-Pt)	0 ... +1,820 °C <sup>15)</sup>	IEC 60584-1:1995	200 K	$\leq \pm 1.73$ °C <sup>12)</sup>	$\leq \pm 0.0500$ °C <sup>7) 12)</sup>
mV sensor	-500 ... +1,800 mV		4 mV	$\leq \pm 0.33$ mV <sup>13)</sup>	$\leq \pm 0.0311$ mV <sup>7) 13)</sup>

Connection type 1 sensor or 2 sensors  
(for further information, please refer to "designation of terminal connections")

Max. wire resistance 5 k $\Omega$  each wire

Cold junction compensation, configurable internal compensation or external with Pt100, with thermostat or off

1) Other units e. g. °F and K possible

2) Measuring deviation (input + output) at ambient temperature 23 °C  $\pm$  3 K, without influence of lead resistance; example calculation see page 5

3) Temperature coefficient (input + output) per °C

4) x configurable between 10 ... 1,000

5) Based on 3-wire Pt100, Ni100, 150 °C MV

6) Based on 150 °C MV

7) In ambient temperature range -40 ... +85 °C

8) Based on a sensor with max. 5 k $\Omega$

9)  $R_{total}$ : 10 ... 100 k $\Omega$

10) Based on a potentiometer value of 50 %

11) Based on 400 °C MV with cold junction compensation error

12) Based on 1,000 °C MV with cold junction compensation error

13) Based on measuring range 0 ... 1 V, 400 mV MV

14) The transmitter can be configured below these limits but not recommended due to loss of accuracy.

15) Specification valid only for measuring range between 450 ... 1,820 °C

MV = Measuring value (temperature measuring values in °C)

### Note:

The transmitter can be configured below these limits but not recommended due to loss of accuracy.

The selection of the sensor is only possible via the HART® software (e.g. WIKA\_T32) or the HART® communicator (e.g. FC475, MFC4150).

WIKA configuration software WIKA\_T32: free download from [www.wika.com](http://www.wika.com)

## User linearisation

Via software, customer-specific sensor characteristics can be stored in the transmitter, so that further sensor types can be used. Number of data points: minimum 2; maximum 30

## Monitoring functionality with 2 sensors connected (dual sensors)

### Redundancy

In the case of a sensor error (sensor-break, wire resistance too high or outside the measuring range of the sensor) of one of the two sensors, the process value will be the value from the error-free sensor. Once the error is rectified, the process value will again be based on the two sensors or on sensor 1.

### Ageing-control (sensor-drift-monitoring)

An error signal on the output is activated if the value of the temperature difference between sensor 1 and sensor 2 is higher than a set value, which can be selected by the user. This monitoring only generates a signal if two valid sensor values can be determined and the temperature difference is higher than the selected limit value.

(Cannot be selected for the 'Difference' sensor function, since the output signal already indicates the difference value).

## Sensor functionality when 2 sensors have been connected (dual sensor)

### Sensor 1, sensor 2 redundant:

The 4 ... 20 mA output signal delivers the process value of sensor 1. If sensor 1 fails, the process value of sensor 2 is output (sensor 2 is redundant).

### Average

The 4 ... 20 mA output signal delivers the average of the two values from sensor 1 and sensor 2. If one sensor fails, the process value of the working sensor is output.

### Minimum value



The 4 ... 20 mA output signal delivers the lower of the two values from sensor 1 and sensor 2. If one sensor fails, the process value of the working sensor is output.

### Maximum value

The 4 ... 20 mA output signal delivers the higher of the two values from sensor 1 and sensor 2. If one sensor fails, the process value of the working sensor is output.

### Difference

The 4 ... 20 mA output signal delivers the difference of the two values from sensor 1 and sensor 2. If one sensor fails, an error signal will be activated.

Display, operating unit	Model TIF50	Models TIF52
■ Principle	LCD, rotatable in 10° steps	
■ Measured value	7-segment LCD, 5-digit, character size 9 mm	
■ Bar graph	20-segment LCD	
■ Information line	14-segment LCD, 6-digit, character size 5.5 mm	
■ Status indicators	 : HART® mode (signalling of HART® parameter adoption)  : Unit lock  : Warnings or error messages	
■ Indication range	-9999 ... 99999	
Measuring rate	approx. 4/s	
Accuracy	±0.1 % of the measuring span	±0.05 % of the measuring span
Temperature coefficient	±0.1 % of the measuring span / 10 K	
HART® functionality		
■ Access control	-	Secondary master
■ Automatically set parameters		
■ Available commands	-	Unit, measuring range start/end, format, zero point, span, damping, polling address
■ Identified commands	Generic mode: 1, 15, 35, 44	Generic mode: 0, 1, 6, 15, 34, 35, 36, 37, 44
■ Multidrop	not supported	Measured values are automatically taken from the HART® digital data and displayed

## Rise time / damping / measuring rate

Rise time $t_{90}$	approx. 0.8 s
<b>Damping</b> , configurable	<b>off</b> ; configurable between 1 s and 60 s
Turn on time (time to get the first measured value)	max. 15 s
Measuring rate <sup>1)</sup>	measured value update approx. 3/s

1) Valid only for single RTD/Thermocouple sensor

## Analogue output / output limits / signalling / isolation resistance

<b>Analogue output</b> , configurable	<b>linear to temperature per IEC 60751</b> / JIS C1606 / DIN 43760 (for resistance sensors) or linear to temperature per IEC 584 / DIN 43710 (for thermocouples) <b>4 ... 20 mA</b> or 20 ... 4 mA, 2-wire	
<b>Output limits</b> , configurable <b>per NAMUR NE43</b> customer specific, adjustable	lower limit <b>3.8 mA</b> 3.6 ... 4.0 mA	upper limit <b>20.5 mA</b> 20.0 ... 21.5 mA
<b>Current value for signalling</b> , configurable <b>per NAMUR NE43</b> default value	<b>down scale</b> <b>&lt; 3.6 mA (3.5 mA)</b> 3.5 ... 12.0 mA	<b>up scale</b> <b>&gt; 21.0 mA (21.5 mA)</b> 12.0 ... 23.0 mA
In simulation mode, independent from input signal, simulation value configurable from 3.5 ... 23.0 mA		
Load $R_A$ (without HART®)	$R_A \leq (U_B - 13.5 \text{ V}) / 0.023 \text{ A}$ with $R_A$ in $\Omega$ and $U_B$ in V	
Load $R_A$ (with HART®)	$R_A \leq (U_B - 14.5 \text{ V}) / 0.023 \text{ A}$ with $R_A$ in $\Omega$ and $U_B$ in V	
Insulation voltage (input to analogue output)	AC 1,200 V, (50 Hz / 60 Hz); 1 s	
Insulation specification to DIN EN 60664-1:2003	Overvoltage category III	

bold: basic configuration

## Explosion protection / power supply

Model	Approvals	Permissible ambient/storage temperature (in accordance with the relevant temperature classes)	Safety-related maximum values for Sensor (connections 1 up to 4)	Current loop (connections $\pm$ )	Power supply $U_B$ (DC)
TIF50-S, TIF52-S	without	{-50} -40 ... +85 °C	-	-	14.5 ... 42 V
TIF50-F, TIF52-F	Flameproof enclosure BVS 10 ATEX E 158 IECEX BVS 10.0103  II 2G Ex d IIC T6/T5/T4 Gb II 2G Ex db IIC T6/T5/T4 Ex d IIC T6/T5/T4 Gb Ex db IIC T6/T5/T4	-40 ... +85 °C at T4 -40 ... +75 °C at T5 -40 ... +60 °C at T6	-	$U_M = 30 \text{ V}$ $P_M = 2 \text{ W}$	14.5 ... 30 V
TIF50-I, TIF52-I	Intrinsically safe equipment 1) BVS 10 ATEX E 016 X IECEX BVS 10.0037X  II (1) 2G Ex ia [ia Ga] IIC T4/T5/T6 Gb II (1) 2D Ex ia [ia Da] IIIC T120°C Db II 2D Ex ia IIc T4/T5/T6 Gb II 2D Ex ia IIIC T120 °C Db	-40 ... +85 °C at T4 -40 ... +75 °C at T5 -40 ... +60 °C at T6  -40 ... +40 °C ( $P_i = 680 \text{ mW}$ ) -40 ... +70 °C ( $P_i = 650 \text{ mW}$ )	$U_i \leq 30 \text{ V}$ $I_i \leq 550 \text{ mA}$ $P_i \leq 1.5 \text{ W}$ at sensor $C_i$ & $L_i$ are negligible $C_i = 100 \text{ pF/m cable}$ $L_i = 0.65 \text{ } \mu\text{H/m cable}$	$U_i \leq 29 \text{ V}$ $I_i \leq 100 \text{ mA}$ $P_i \leq 680 \text{ mW}$ $C_i = 12 \text{ nF}$ $L_i = 2.2 \text{ } \mu\text{H}$	14.5 ... 29 V

1) The installation conditions for the transmitters and displays must be considered for the final application.

## Monitoring

Test current for sensor monitoring <sup>2)</sup>	Nom. 20 $\mu\text{A}$ during test cycle, otherwise 0 $\mu\text{A}$
Monitoring NAMUR NE89 (monitoring of input lead resistance)	
■ Resistance thermometer (Pt100, 4-wire)	$R_{L1} + R_{L4} > 100 \Omega$ with hysteresis 5 $\Omega$ $R_{L2} + R_{L3} > 100 \Omega$ with hysteresis 5 $\Omega$
■ Thermocouple	$R_{L1} + R_{L4} + R_{\text{thermocouple}} > 10 \text{ k}\Omega$ with hysteresis 100 $\Omega$
Sensor burnout monitoring	Activated
Self monitoring	Active permanently, e.g. RAM/ROM test, logical program operating checks and validity check
Measuring range monitoring	Monitoring of the set measuring range for upper/lower deviations
Monitoring of input lead resistance (3-wire)	Monitoring for resistance difference between lead 3 and 4; an error will be set, if there is a difference ( $> 0.5 \Omega$ ) between leads 3 and 4

2) Only for thermocouple

## Measuring deviation / temperature coefficient / long-term stability

Effect of load	not measurable				
Power supply effect	not measurable				
Warm-up time	after approx. 5 minutes the instrument will function to the specified technical data (accuracy)				
Input	Measuring deviation per DIN EN 60770, 23 °C ±3 K	Average temperature coefficient (TC) for each 10 K ambient temperature change in the range -40 ... +85 °C	Connection lead effects	Long-term stability 1 year	
Resistance thermometer Pt100/ JPt100/Ni100 <sup>1)</sup>	-200 °C ≤ MV ≤ 200 °C: ±0.10 K MV > 200 °C: ±(0.1 K + 0.01 %  MV-200 K ) <sup>2)</sup>	±(0.06 K + 0.015 % MV)	4-wire: no effect (0 to 50 Ω each wire) 3-wire: ±0.02 Ω / 10 Ω (0 to 50 Ω each wire) 2-wire: resistor of the connection leads <sup>3)</sup>	±60 mΩ or 0.05 % of MV, whichever is greater	
Resistance sensor	≤ 890 Ω: 0.053 Ω <sup>4)</sup> or 0.015 % MV <sup>5)</sup> ≤ 2,140 Ω: 0.128 Ω <sup>4)</sup> or 0.015 % MV <sup>5)</sup> ≤ 4,390 Ω: 0.263 Ω <sup>4)</sup> or 0.015 % MV <sup>5)</sup> ≤ 8,380 Ω: 0.503 Ω <sup>4)</sup> or 0.015 % MV <sup>5)</sup>	±(0.01 Ω + 0.01 % MV)			
Potentiometer	R <sub>part</sub> /R <sub>total</sub> is max. ±0.5 %	±(0.1 % MV)		±20 μV or 0.05 % of MV, whichever is greater	
Thermocouples Type E, J	-150 °C < MV < 0 °C: ±(0.3 K + 0.2 %  MV ) MV > 0 °C: ±(0.3 K + 0.03 % MV)	Type E: MV > -150 °C: ±(0.1 K + 0.015 % IMV ) Type J: MV > -150 °C: ±(0.07 K + 0.02 %  MV )	6 μV / 1,000 Ω <sup>6)</sup>		
Type T, U	-150 °C < MV < 0 °C: ±(0.4 K + 0.2 %  MV ) MV > 0 °C: ±(0.4 K + 0.01 % MV)	-150 °C < MV < 0 °C: ±(0.07 K + 0.04 % MV) MV > 0 °C: ±(0.07 K + 0.01 % MV)			
Type R, S	50 °C < MV < 400 °C: ±(1.45 K + 0.12 %  MV-400 K ) 400 °C < MV < 1,600 °C: ±(1.45 K + 0.01 %  MV-400 K )	Type R: 50 °C < MV < 1,600 °C: ±(0.3 K + 0.01 %  MV - 400 K ) Type S: 50 °C < MV < 1,600 °C: ±(0.3 K + 0.015 %  MV - 400 K )			
Type B	450 °C < MV < 1,000 °C: ±(1.7 K + 0.2 %  MV - 1,000 K ) MV > 1000 °C: ±1.7 K	450 °C < MV < 1,000 °C: ±(0.4 K + 0.02 %  MV - 1,000 K ) MV > 1,000 °C: ±(0.4 K + 0.005 % (MV - 1,000 K))			
Type K	-150 °C < MV < 0 °C: ±(0.4 K + 0.2 %  MV ) 0 °C < MV < 1300 °C: ±(0.4 K + 0.04 % MV)	-150 °C < MV < 1300 °C: ±(0.1 K + 0.02 %  MV )			
Type L	-150 °C < MV < 0 °C: ±(0.3 K + 0.1 %  MV ) MV > 0 °C: ±(0.3 K + 0.03 % MV)	-150 °C < MV < 0 °C: ±(0.07 K + 0.02 %  MV ) MV > 0 °C: ±(0.07 K + 0.015 % MV)			
Type N	-150 °C < MV < 0 °C: ±(0.5 K + 0.2 %  MV ) MV > 0 °C: ±(0.5 K + 0.03 % MV)	-150 °C < MV < 0 °C: ±(0.1 K + 0.05 % IMV ) MV > 0 °C: ±(0.1 K + 0.02 % MV)			
mV sensor	≤1,160 mV: 10 μV + 0.03 %  MV  >1,160 mV: 15 μV + 0.07 %  MV	2 μV + 0.02 %  MV  100 μV + 0.08 %  MV			
Cold Junction Compensation (CJC) <sup>7)</sup>	±0.8 K	±0.1 K			
<b>Output</b>	±0.03 % of measuring span	±0.03 % of measuring span			±0.05 % of span

### Total measuring deviation

Addition: input + output per DIN EN 60770, 23 °C ±3 K

MV = Measuring value (temperature measuring values in °C)

Measuring span = configurable upper limit of measuring range - configurable lower limit of measuring range

1) For sensor Ptx (x = 10 ... 1000) applies:

for x ≥ 100: permissible error, as for Pt100

for x < 100: permissible error, as for Pt100 with a factor (100/x)

2) Additional error for resistance thermometers in a 3-wire configuration with zero-balanced cable: 0.05 K

3) The specified resistance value of the sensor wire can be subtracted from the calculated measured sensor resistance.

Duplex sensor: configurable for each sensor separately

4) Double value at 3-wire

5) Greater value applies

6) Within a range of 0 ... 10 kΩ wire resistance

7) Only for thermocouple

**Basic configuration:**

**Input signal: Pt100 in 3-wire connection, measuring range: 0 ... 150 °C**

### Example calculation

Pt100 / 4-wire / measuring range 0 ... 150 °C / ambient temperature 33 °C	
Input Pt100, MV < 200 °C	±0.100 K
Input ±(0.03 % of 150 K)	±0.045 K
TC 10 K - input ±(0.06 K + 0.015 % of 150 K)	±0.083 K
TC 10 K - output ±(0.03 % of 150 K)	±0.045 K
<b>Measuring deviation - typical</b> ( $\sqrt{\text{input}^2 + \text{output}^2 + \text{TC}_{\text{input}}^2 + \text{TC}_{\text{output}}^2}$ )	<b>±0.145 K</b>
<b>Measuring deviation - maximum</b> (input+output+TC <sub>input</sub> +TC <sub>output</sub> )	<b>±0.273 K</b>

Thermocouple type K / measuring range 0 ... 400 °C / internal compensation (cold junction) / ambient temperature 23 °C	
Input type K, 0 °C < MV < 1,300 °C	±0.56 K
±(0.4 K + 0.04 % of 400 K)	
Cold junction ±0.8 K	±0.80 K
Output ±(0.03 % of 400 K)	±0.12 K
<b>Measuring deviation - typical</b> ( $\sqrt{\text{input}^2 + \text{cold junction}^2 + \text{output}^2}$ )	<b>±0.98 K</b>
<b>Measuring deviation - maximum</b> (input+cold junction+output)	<b>±1.48 K</b>

## Field case

Material	<ul style="list-style-type: none"> <li>■ Aluminium, window in polycarbonate</li> <li>■ Stainless steel, window in polycarbonate</li> </ul>
Colour	Aluminium: Night blue, RAL 5022      Stainless steel: Silver
Cable glands	3 x M20 x 1.5 or 3 x 1/2 NPT
Ingress protection	IP 66
Weight	Aluminium: approx. 1.5 kg      Stainless steel: approx. 3.7 kg
Dimensions	see drawing

## Ambient conditions

Permissible ambient temperature range	-40 ... +85 °C 1)
Climate class per IEC 654-1: 1993	Cx (-20 ... +85 °C, 35 ... 85 % relative air humidity, no condensation)
Maximum permissible humidity	Relative humidity 93 % ±3 %
Vibration per IEC 60068-2-6: 2007	3 g
Shock per IEC 68-2-27: 1987	30 g
Electromagnetic compatibility (EMC)	EMC directive 2004/108/EC, DIN EN 61326 emission (Group 1, Class B) and immunity (industrial application), as well as per NAMUR NE21

1) Limited display function within ambient temperature range -40 ... -20 °C

## Communication HART® protocol rev. 5 incl. burst mode, Multidrop

Interoperability (i.e. compatibility between components from different manufacturers) is imperative with HART® devices. The field transmitter is compatible with almost every open software and hardware tool; among other things with:

1. User-friendly WIKA configuration software, free-of-charge download via [www.wika.com](http://www.wika.com)
2. HART® communicator HC275 / FC375 / FC475 / MFC4150:
  - T32 Device description is integrated and upgradable with old HC275 versions
3. Asset Management Systems
  - 3.1 AMS: T32\_DD completely integrated and upgradable with old versions
  - 3.2 Simatic PDM: T32\_EDD completely integrated from version 5.1, upgradable with version 5.0.2
  - 3.3 Smart Vision: DTM upgradable per FDT 1.2 standard from SV version 4
  - 3.4 PACTware (see accessories): DTM completely integrated and upgradable as well as all supporting applications with FDT 1.2 interface
  - 3.5 Fieldmate: DTM upgradable

## Attention:

For direct communication via the serial interface of a PC/notebook, a HART® modem is needed (see "Accessories"). As a general rule, parameters which are defined in the scope of the universal HART® commands (e.g. the measuring range) can, in principle, be edited with all HART® configuration tools.

## Load diagram

The permissible load depends on the loop supply voltage.

Load  $R_A \leq (U_B - 13.5 \text{ V}) / 0.023 \text{ A}$  with  $R_A$  in  $\Omega$  and  $U_B$  in V (without HART®)

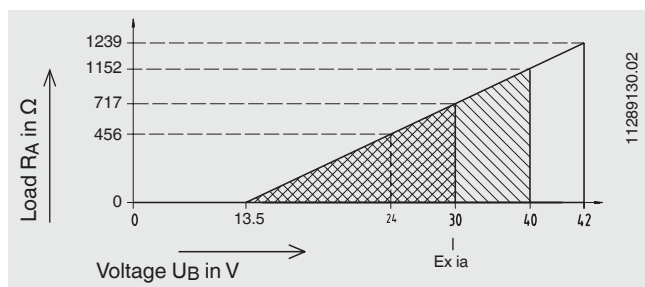

# Designation of terminal connectors

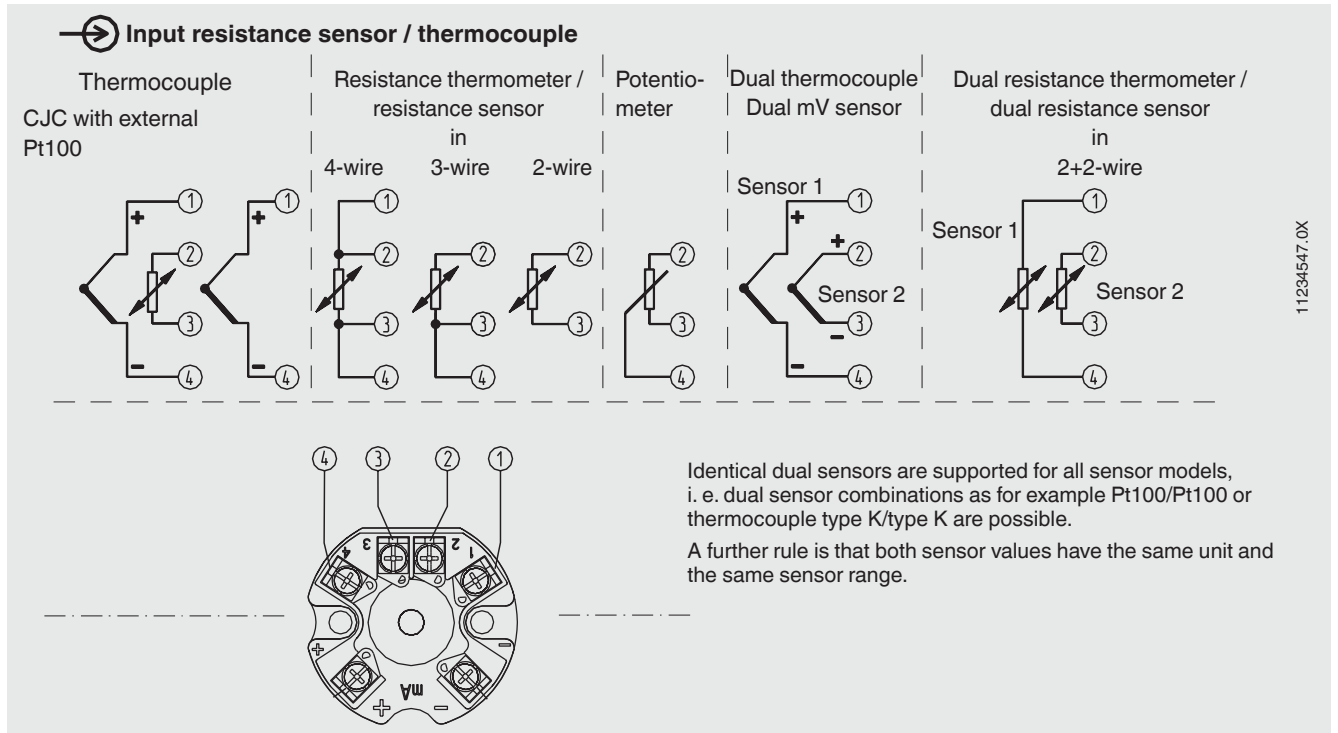

11234547\_0X

## Electrical connection

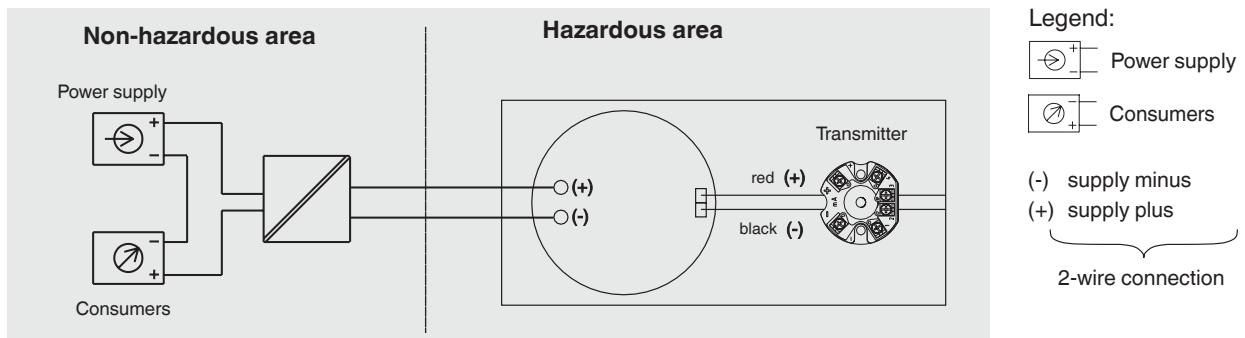



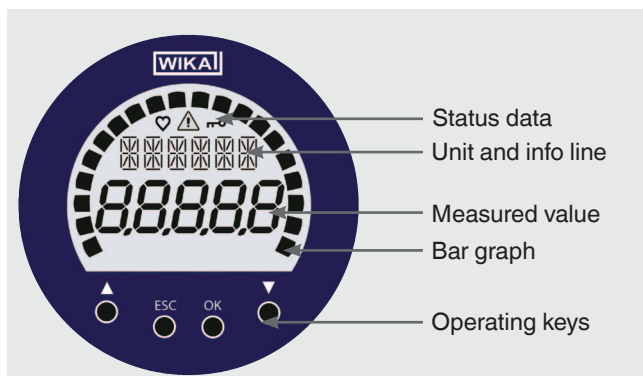

## User interface

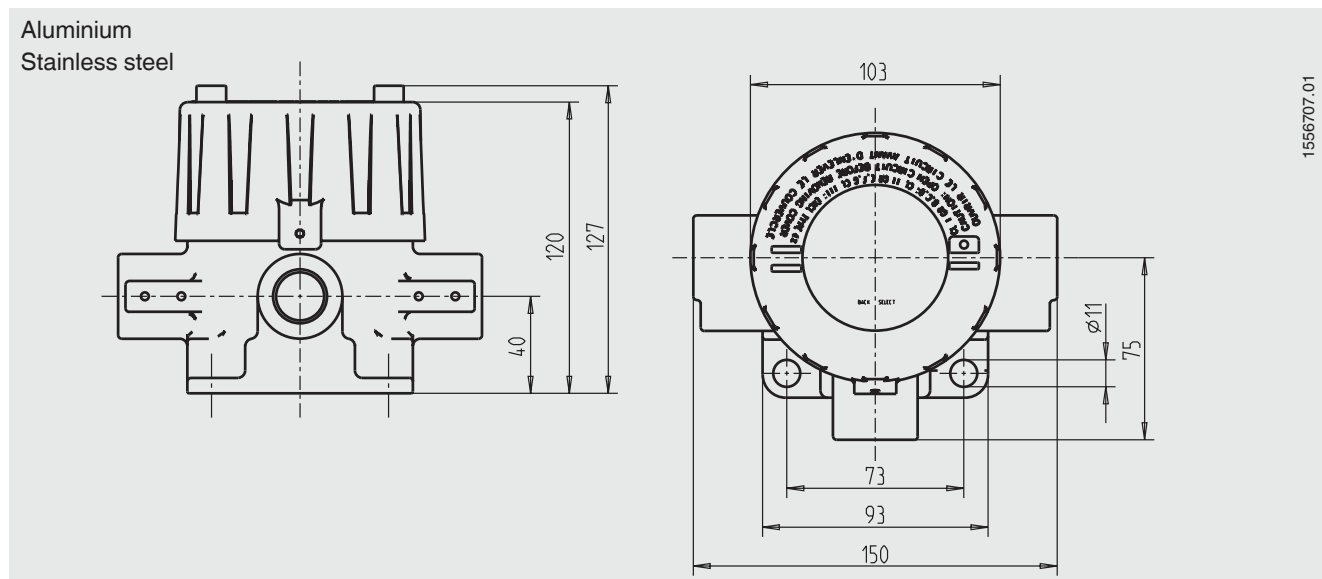

## Dimensions in mm



## Accessories

Model	Special features	Order No.
Model 010031	 HART® modem for USB-interface, specifically designed for use with modern notebooks	11025166
Model 010001	HART® modem for RS-232 interface	7957522
Model 010041	HART® modem for Bluetooth interface [EEx ia] IIC	11364254
FC475HP1EKLUGMT	 HART® protocol, Li-Ion battery, power supply AC 90 ... 240 V, with EASY UPGRADE; ATEX, FM and CSA (intrinsically safe)	on request
FC475FP1EKLUGMT	HART protocol, FOUNDATION Fieldbus, Li-Ion-battery, power supply AC 90 ... 240 V, with EASY UPGRADE; ATEX, FM and CSA (intrinsically safe)	on request
MFC4150	 HART® protocol, universal power supply, cable set with 250 Ω resistance, with DOF upgrade, with Ex-protection 	11405333
Magnetic quick connector magWIK	 <ul style="list-style-type: none"> <li>■ Replacement for crocodile clips and HART® terminals</li> <li>■ Fast, safe and tight electrical connection</li> <li>■ For all configuration and calibration processes</li> </ul>	11604328



## CE conformity

### EMC directive

2004/108/EG, EN 61326 emission (group 1, class B) and interference immunity (industrial application)

### ATEX directive

94/9/EG

## Approvals

- **IECEX**, international certification for the Ex area
- **GOST-R**, import certificate, Russia

## Certificates (option)

- 2.2 test report
- 3.1 inspection certificate
- DKD/DAkkS calibration certificate

Approvals and certificates, see website

## Ordering information

Model / Display module / Explosion protection / Case material / Transmitter / Cable glands / Threaded connection for cable glands / Certificates / Options

© 2011 WIKA Alexander Wiegand SE & Co. KG, all rights reserved.  
The specifications given in this document represent the state of engineering at the time of publishing.  
We reserve the right to make modifications to the specifications and materials.

